

# QP1 Series - Positive displacement pumps

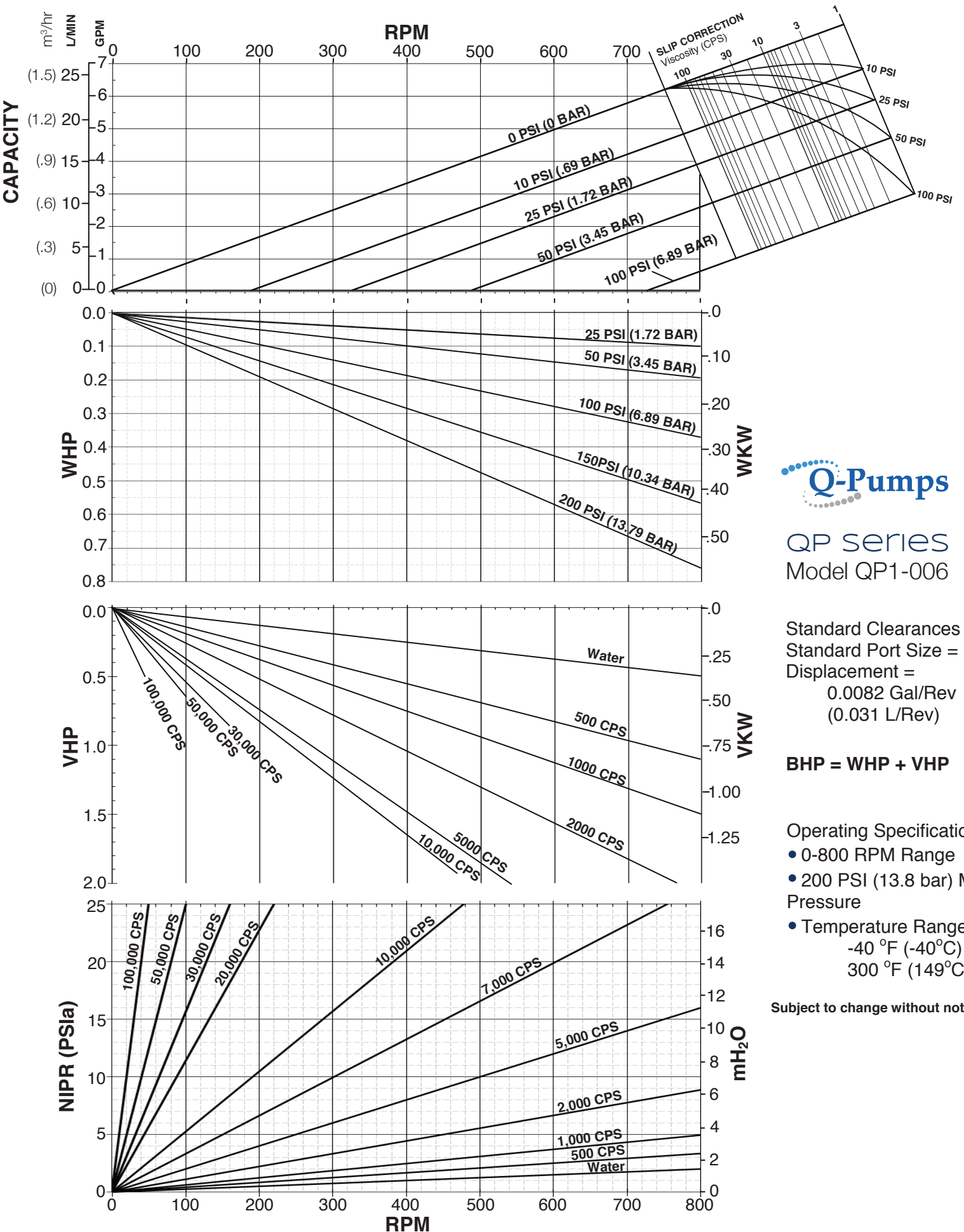

QP series  
Model QP1-006

Standard Clearances  
Standard Port Size = 1.0"  
Displacement =  
0.0082 Gal/Rev  
(0.031 L/Rev)

**BHP = WHP + VHP**

- Operating Specifications:
- 0-800 RPM Range
  - 200 PSI (13.8 bar) Max. Pressure
  - Temperature Range  
-40 °F (-40°C) to  
300 °F (149°C)

Subject to change without notice

# QP1 Series - Positive displacement pumps

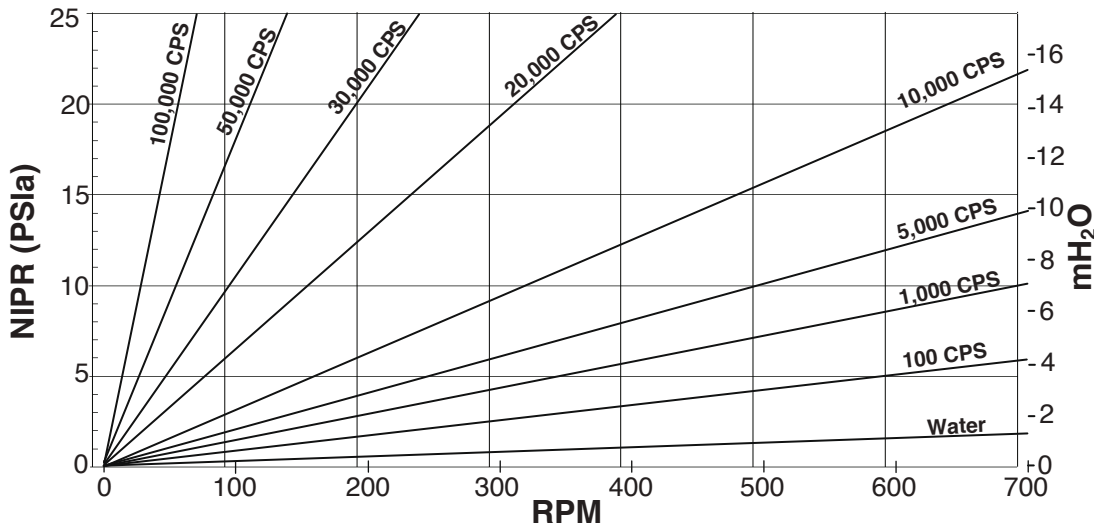
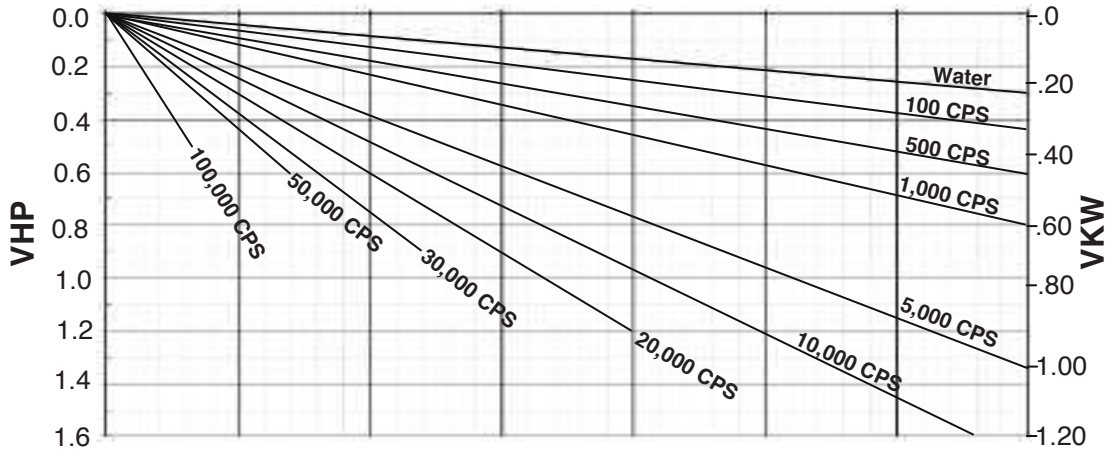
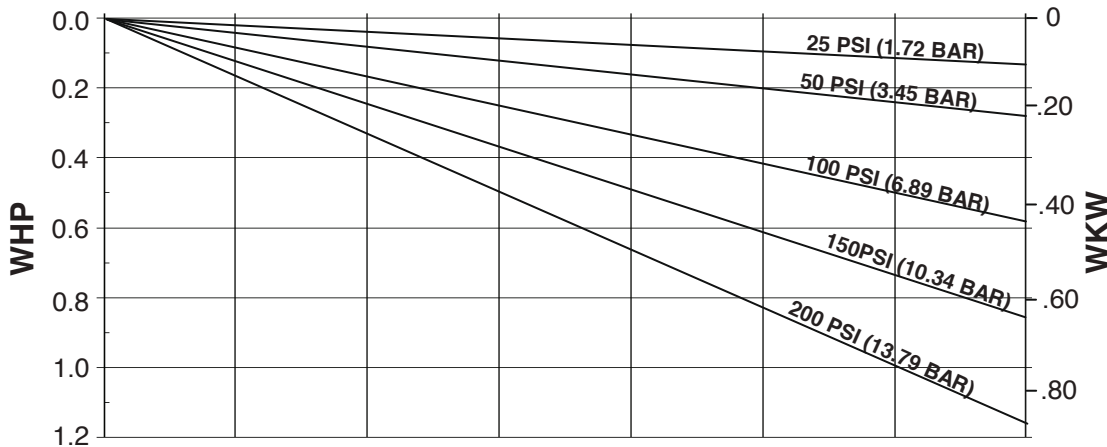
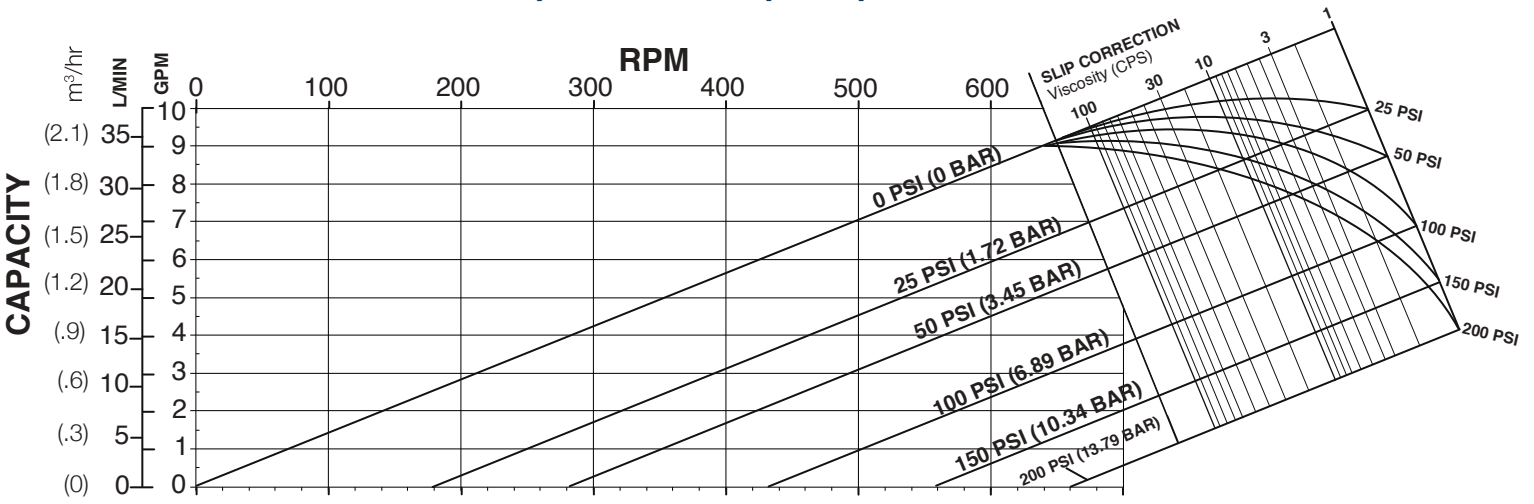

QP Series  
Model QP1-015

Standard Clearances  
Standard Port Size = 1.5"  
Displacement =  
0.014 Gal/Rev  
(0.054 L/Rev)

**BHP = WHP + VHP**

- Operating Specifications:
- 0-700 RPM Range
  - 200 PSI (13.8 bar) Max. Pressure
  - Temperature Range  
-40 °F (-40°C) to  
300 °F (149°C)

Subject to change without notice

# QP1 Series - Positive displacement pumps

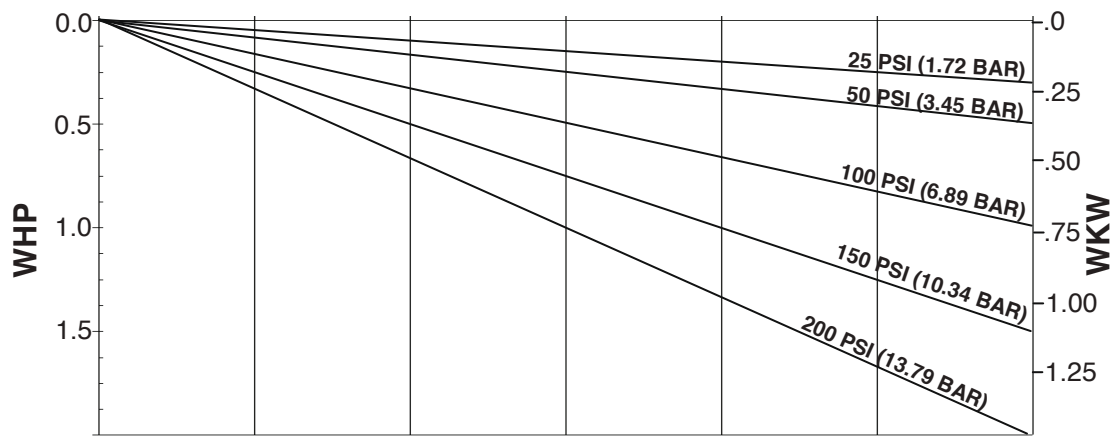
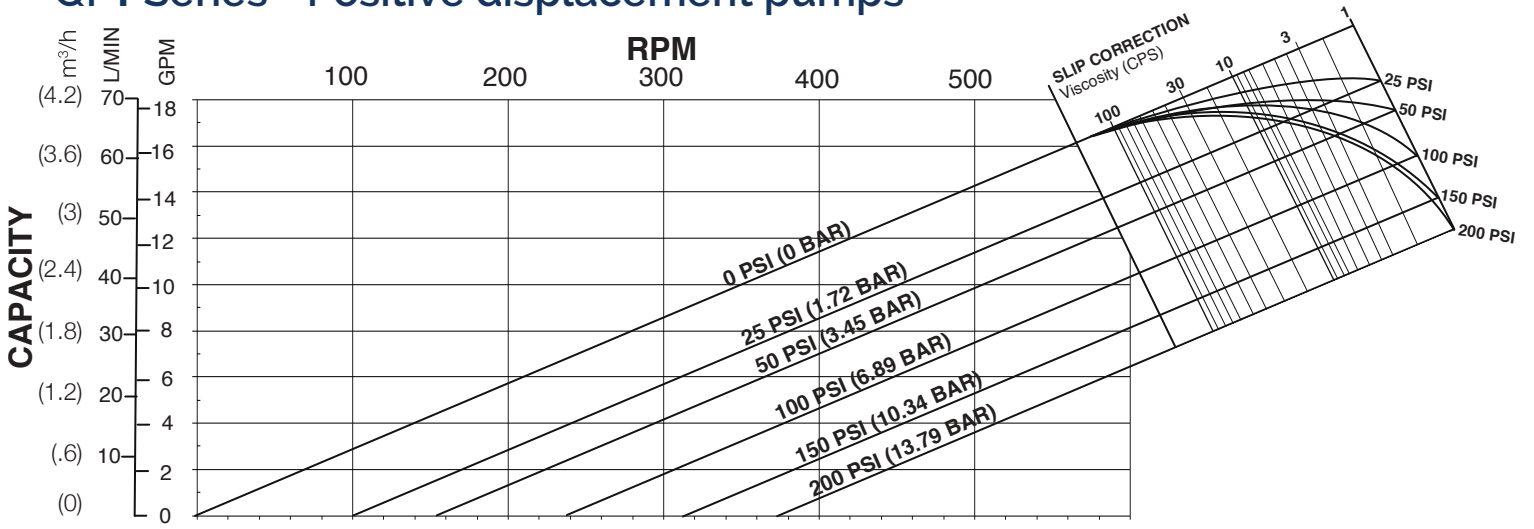

QP Series  
Model QP1-018

Standard Clearances  
Standard Port Size = 1.5"  
Displacement =  
0.029 Gal/Rev  
(0.108 L/Rev)

**BHP = WHP + VHP**

- Operating Specifications:
- 0-600 RPM Range
  - 200 PSI (13.8 bar) Max. Pressure
  - Temperature Range -40 °F (-40°C) to 300 °F (149°C)

Subject to change without notice

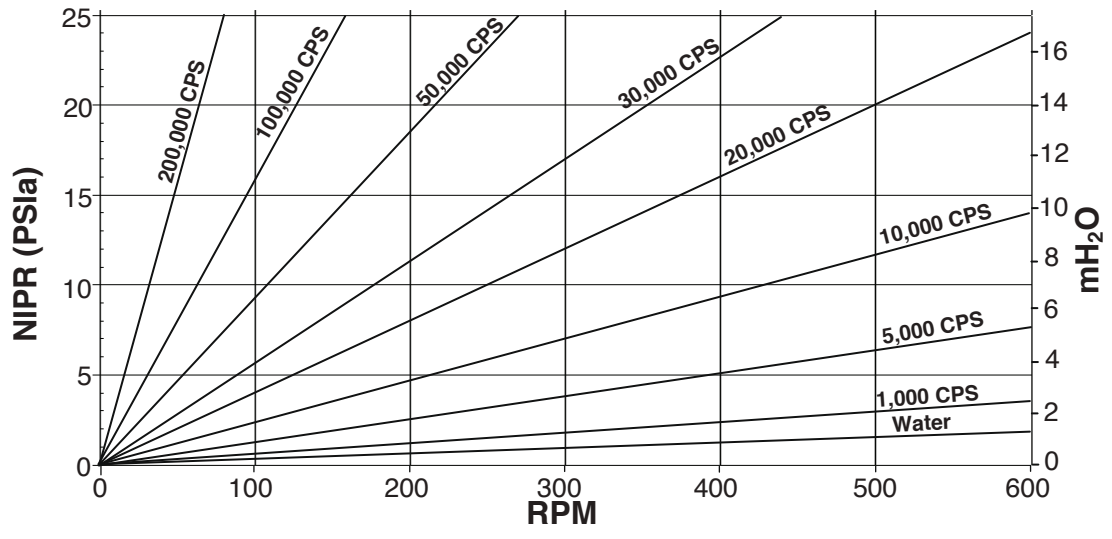
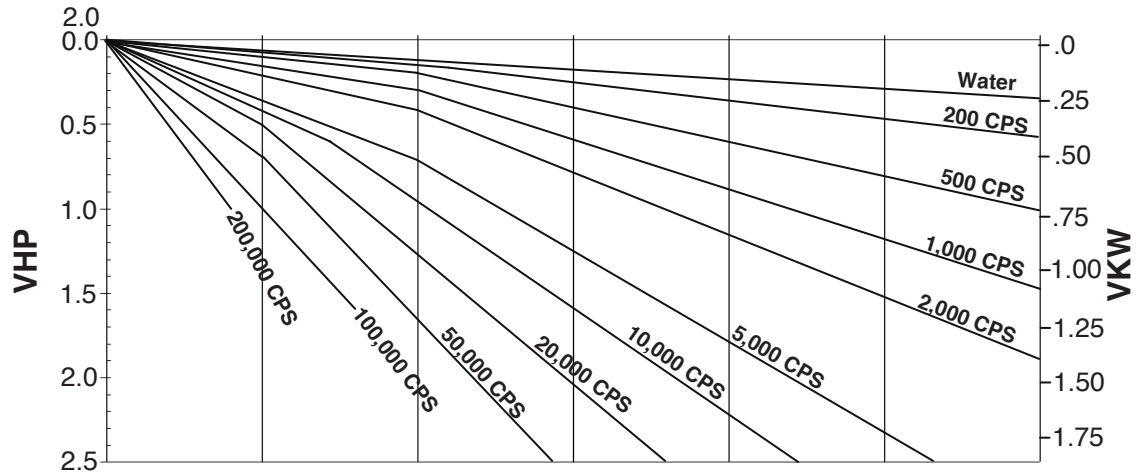

# QP1 Series - Positive displacement pumps

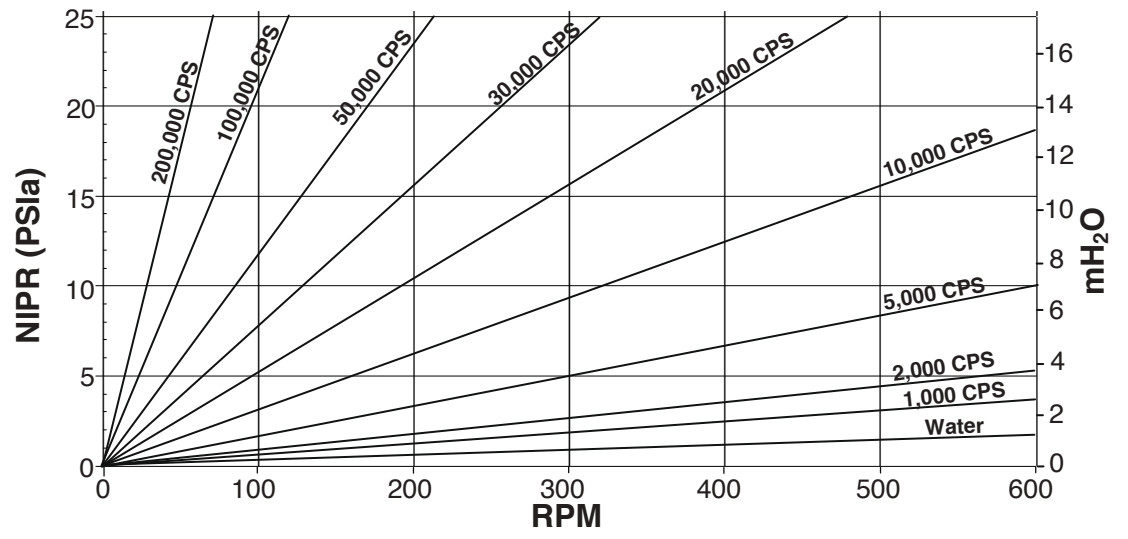
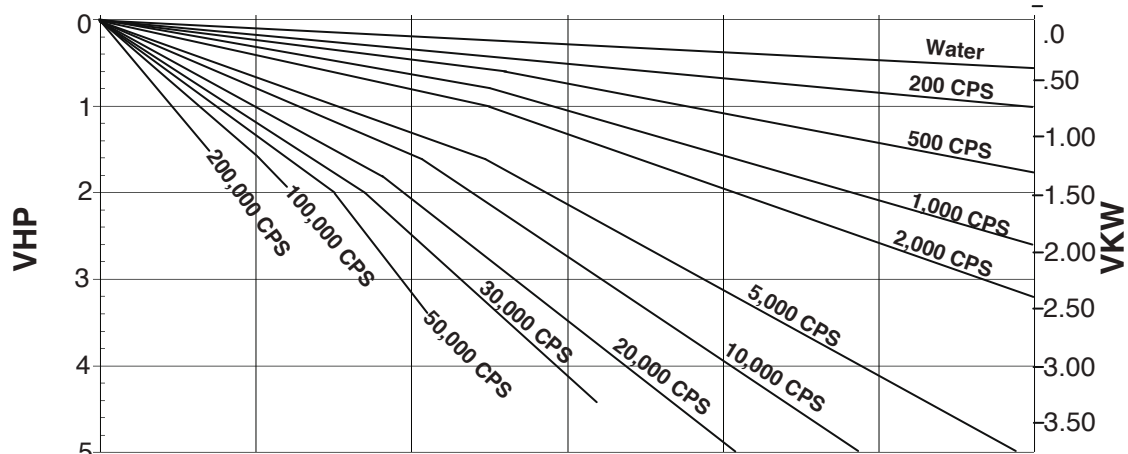
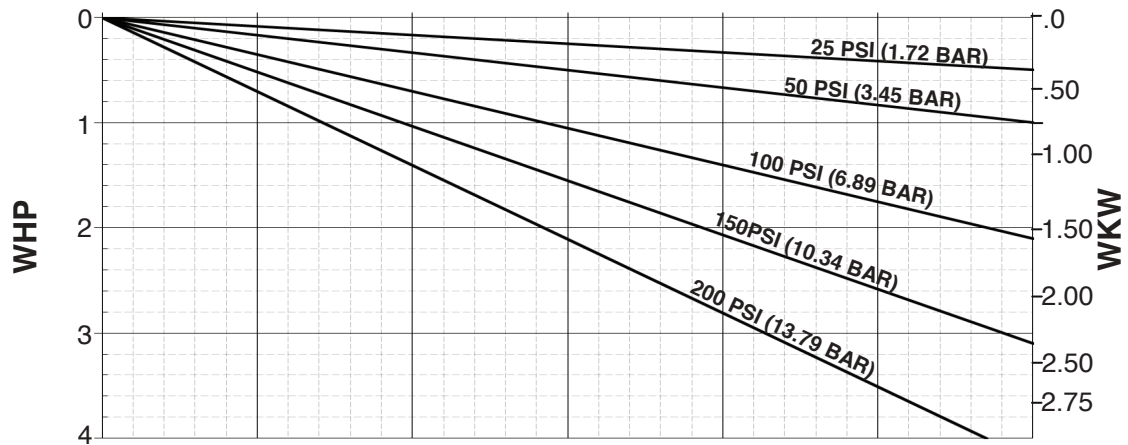
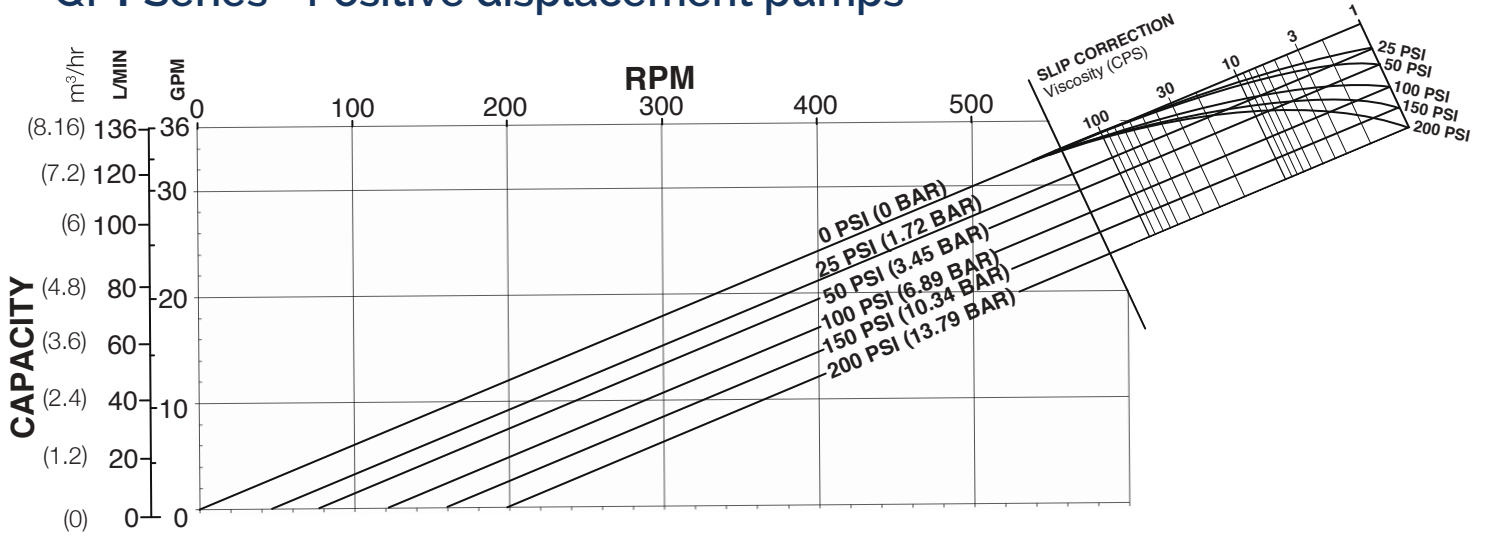

QP Series  
Model QP1-030

Standard Clearances  
Standard Port Size = 1.5"  
Displacement =  
0.060 Gal/Rev  
(0.227 L/Rev)

**BHP = WHP + VHP**

- Operating Specifications:
- 0-600 RPM Range
  - 200 PSI (13.8 bar) Max. Pressure
  - Temperature Range -40 °F (-40°C) to 300 °F (149°C)

Subject to change without notice

# QP1 Series - Positive displacement pumps

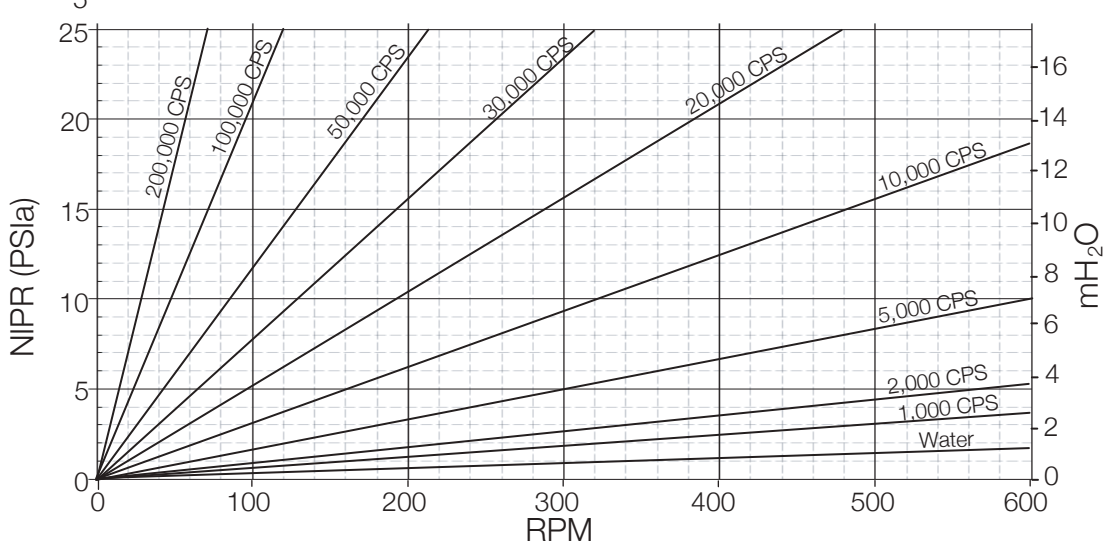
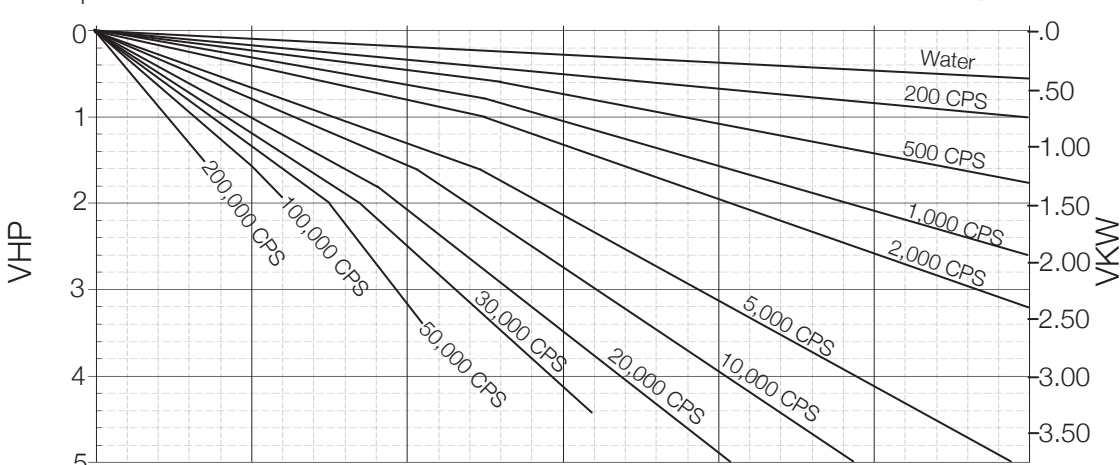
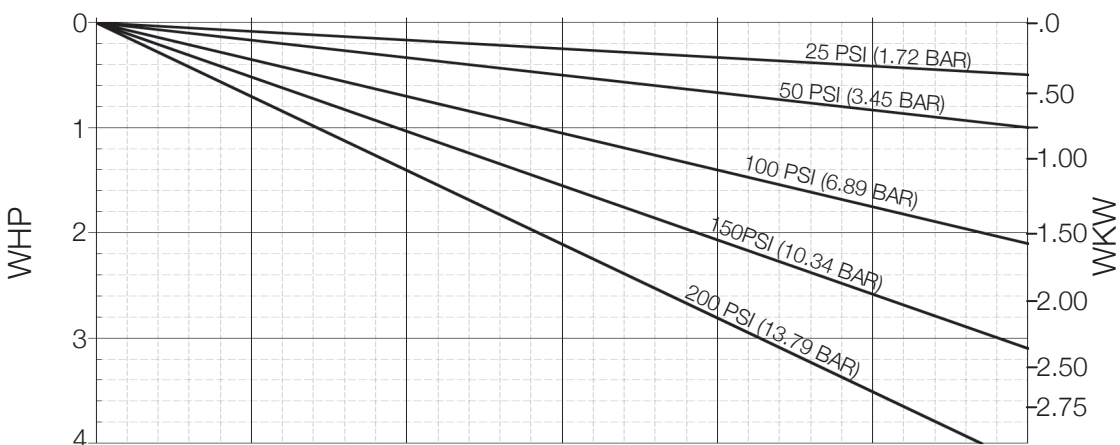
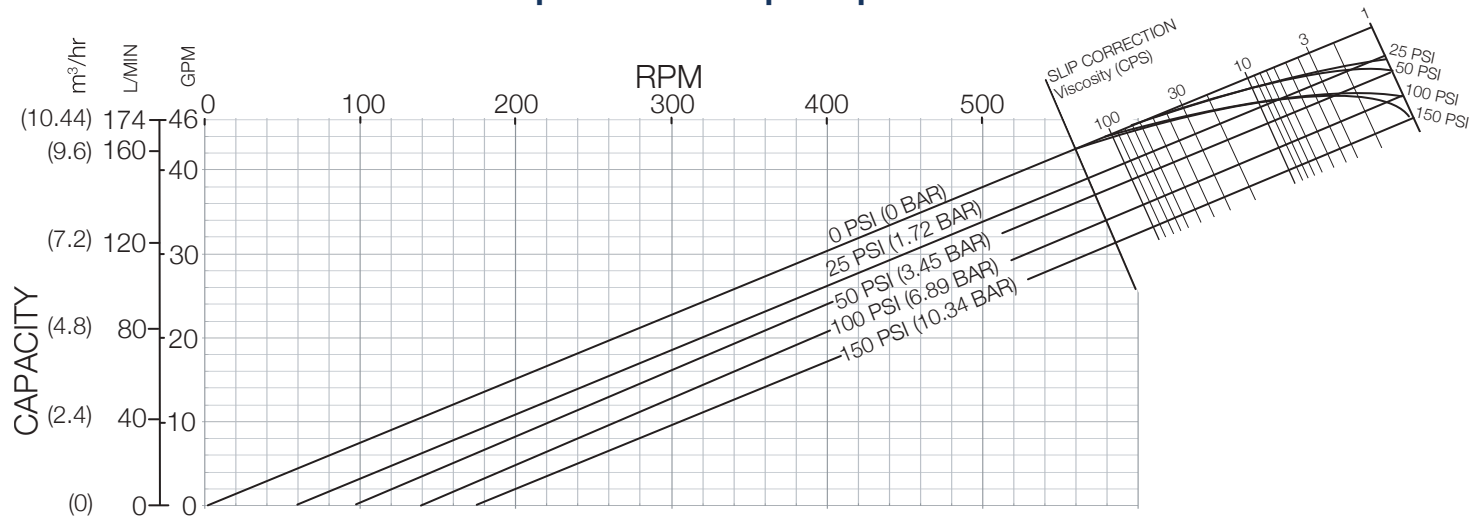

QP Series  
Model QP1-040

Standard Clearances  
Standard Port Size = 2.0"  
Displacement =  
0.076Gal/Rev  
(0.288 L/Rev)

**BHP = WHP + VHP**

- Operating Specifications:
- 0-600 RPM Range
  - 150 PSI (10.3 bar) Max. Pressure
  - Temperature Range -40 °F (-40°C) to 300 °F (149 °C)

Subject to change without notice

# QP1 Series - Positive displacement pumps

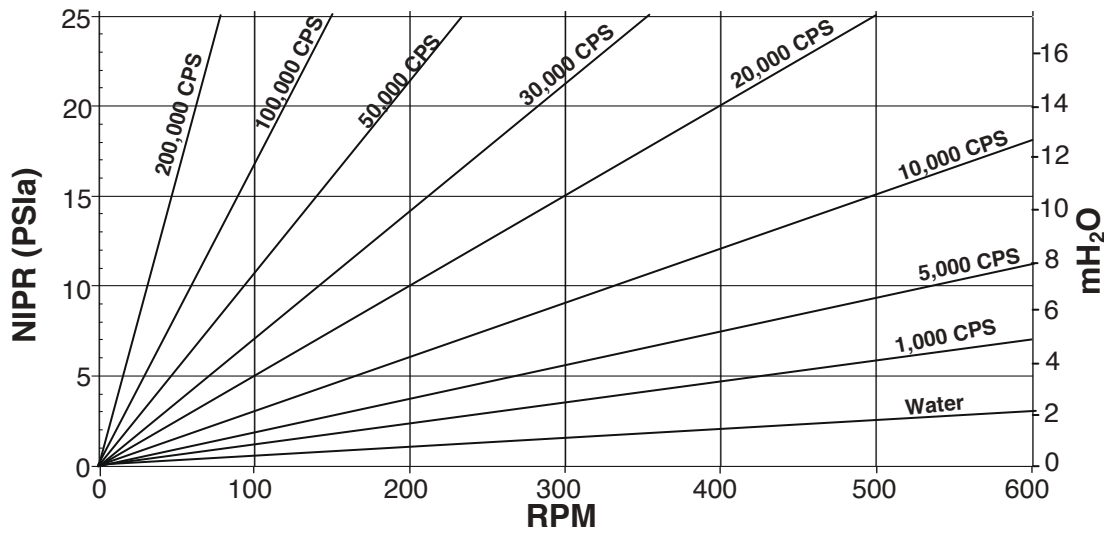
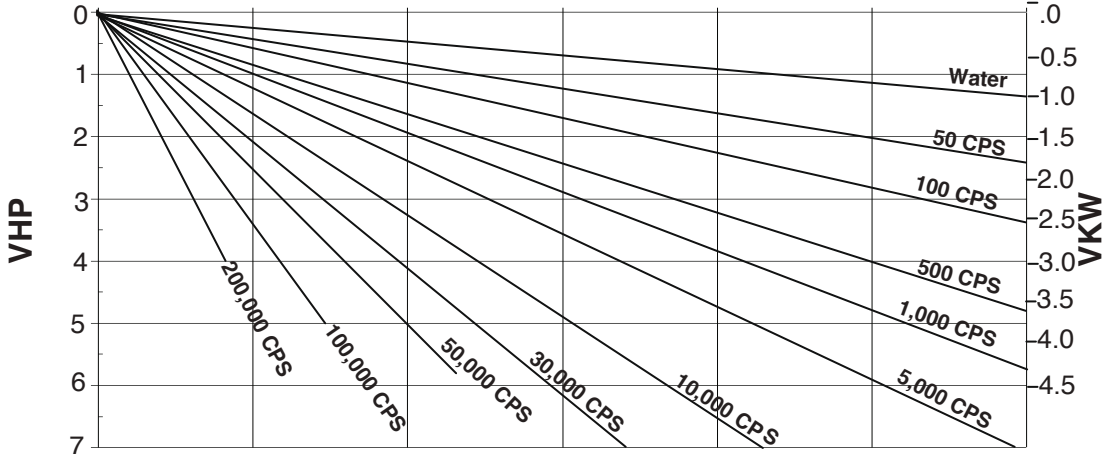
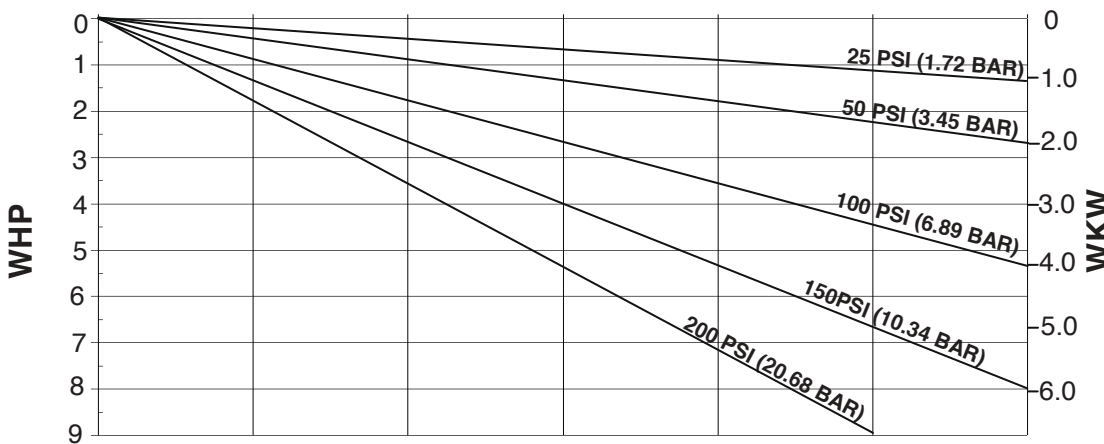
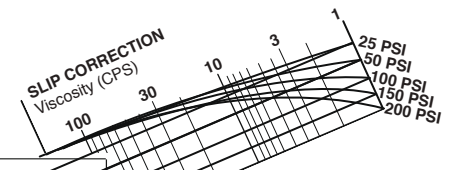
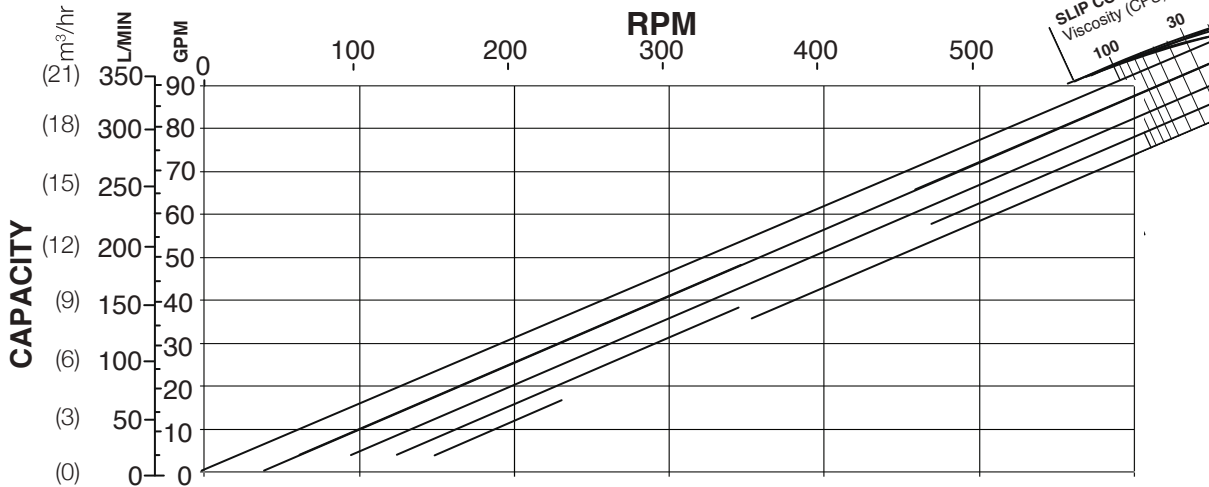

QP Series  
Model QP1-060

Standard Clearances  
Standard Port Size = 2.5"  
Displacement =  
0.153 Gal/Rev  
(0.579 L/Rev)

**BHP = WHP + VHP**

- Operating Specifications:
- 0-600 RPM Range
  - 200 PSI (13.8 bar) Max. Pressure
  - Temperature Range  
-40 °F (-40°C) to  
300 °F (149°C)

Subject to change without notice

# QP1 Series - Positive displacement pumps

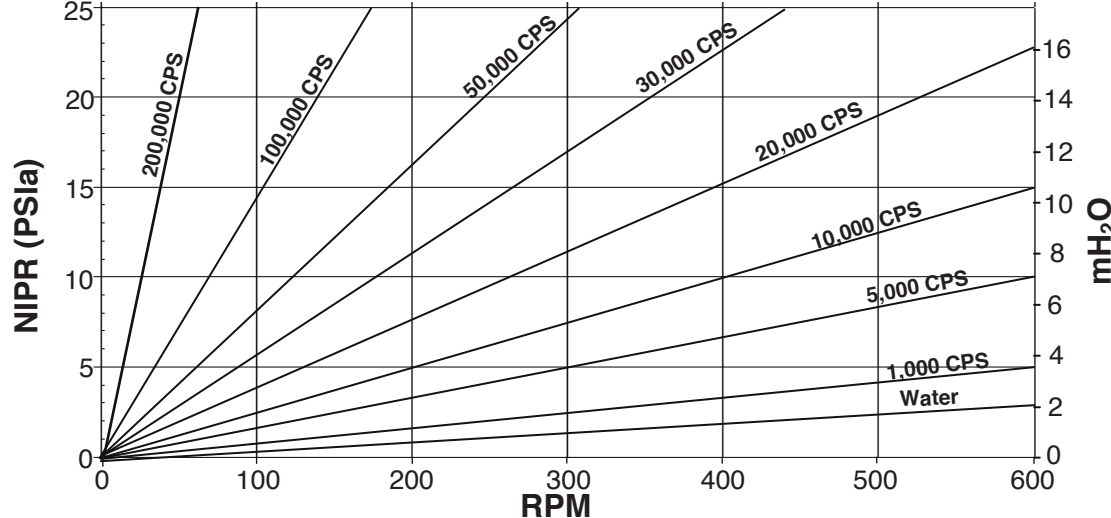
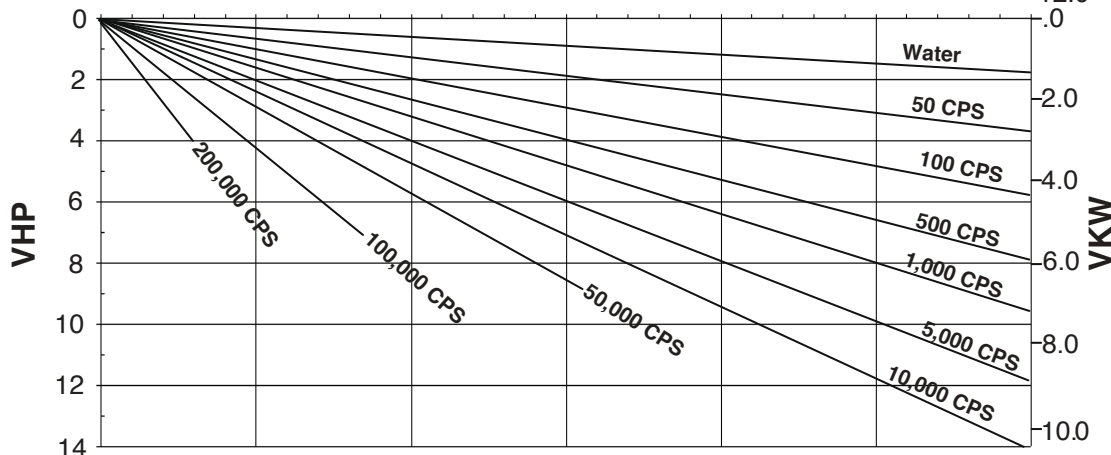
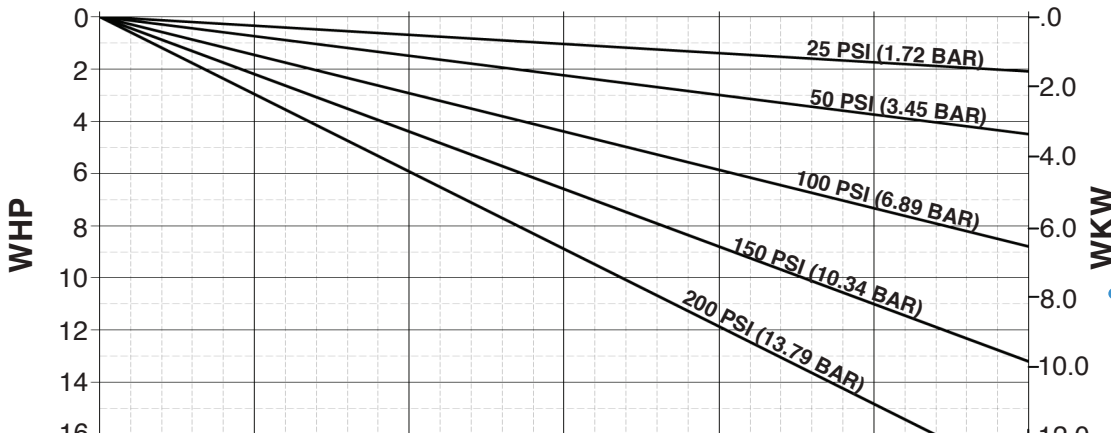
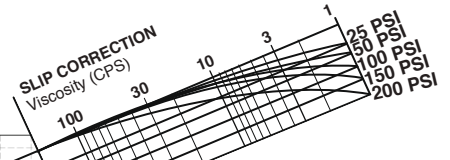
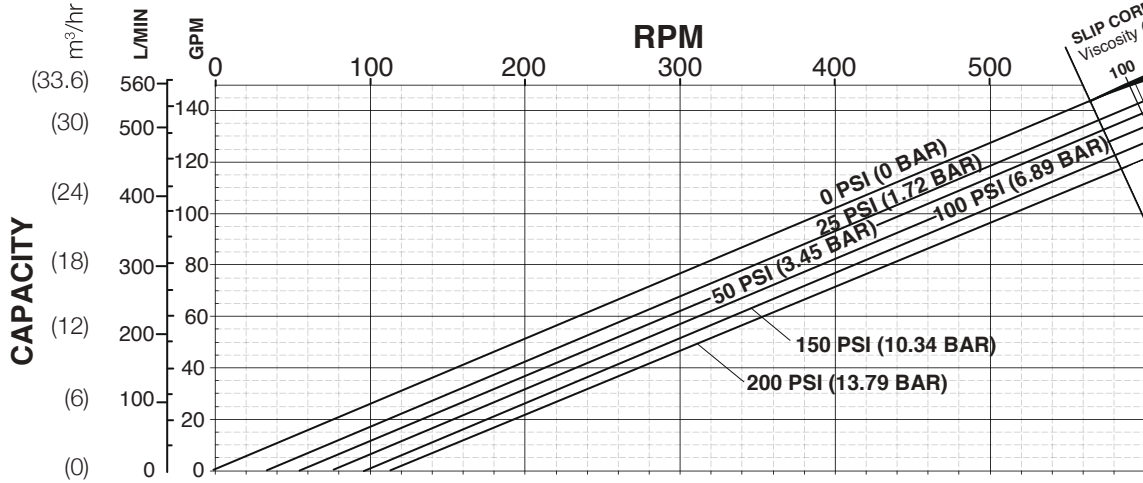

QP Series  
 Model QP1-130

Standard Clearances  
 Standard Port Size = 3.0"  
 Displacement =  
 0.254 Gal/Rev  
 (0.961 L/Rev)

**BHP = WHP + VHP**

- Operating Specifications:
- 0-600 RPM Range
  - 200 PSI (13.8 bar) Max. Pressure
  - Temperature Range  
 -40 °F (-40°C) to  
 300 °F (149°C)

Subject to change without notice

# QP1 Series - Positive displacement pumps

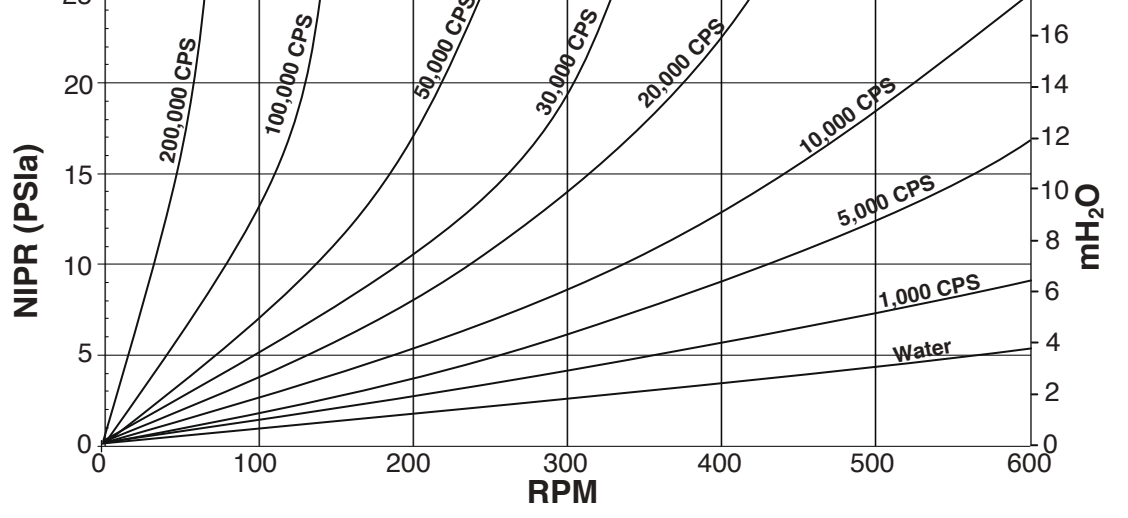
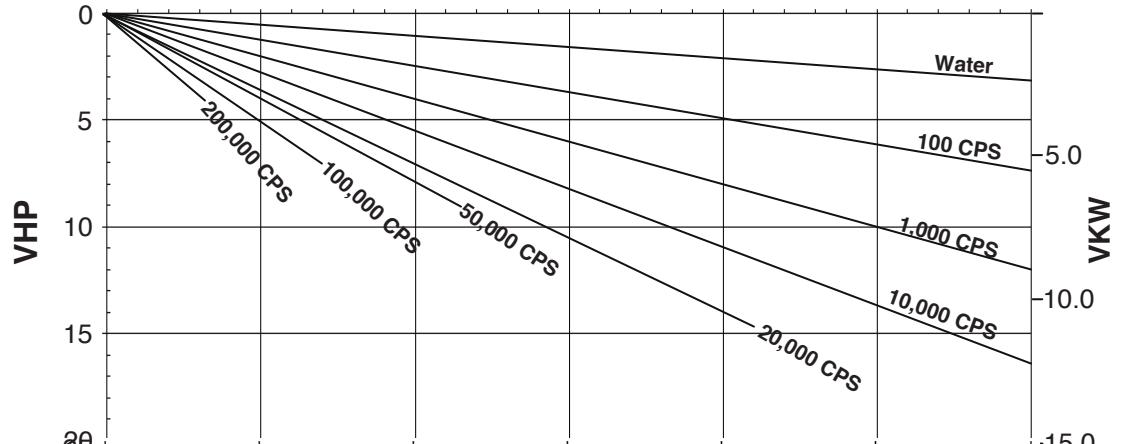
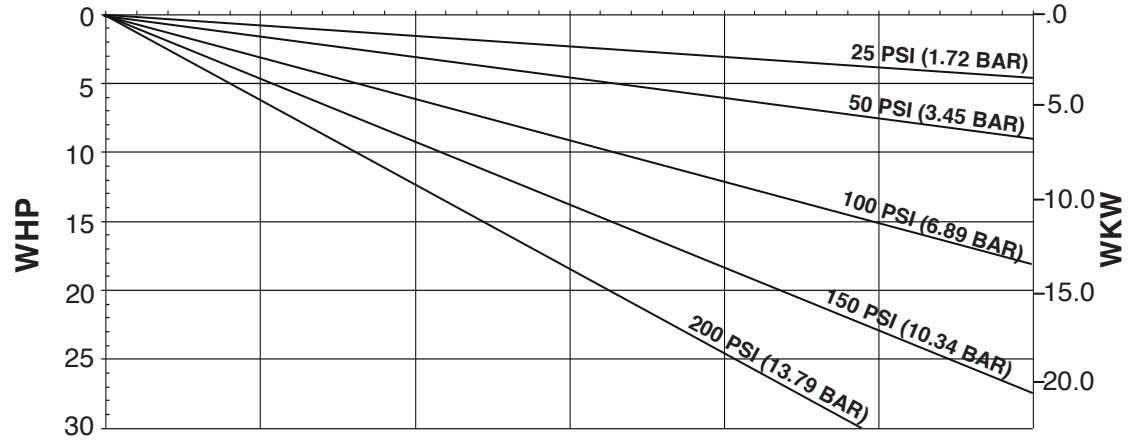
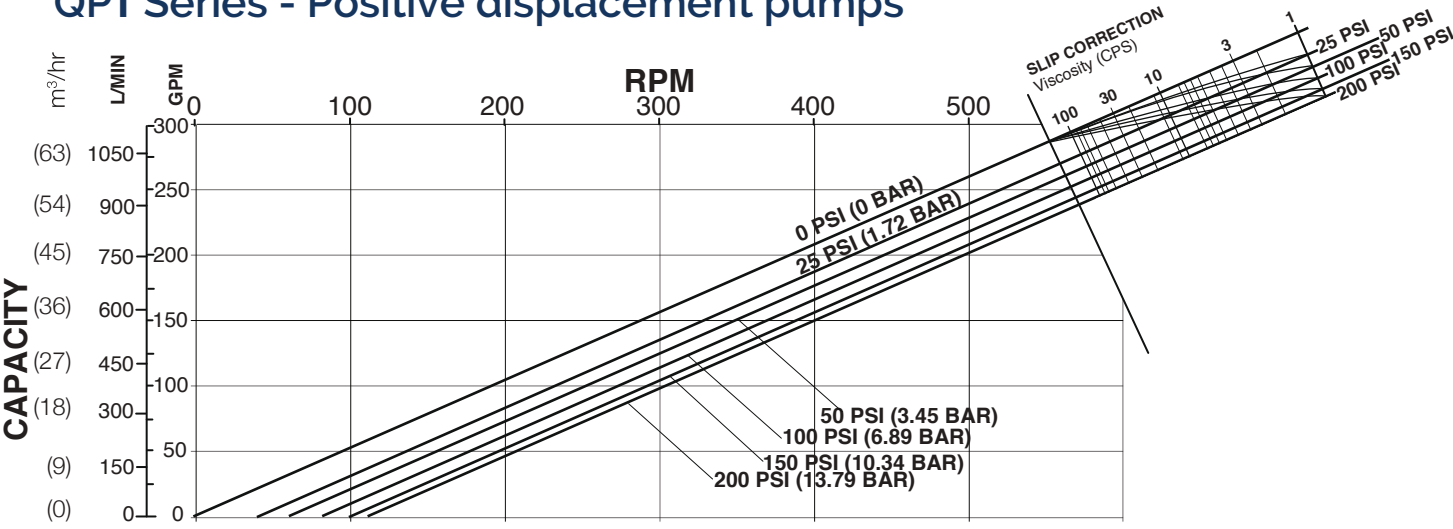

QP Series  
Model QP1-220

Standard Clearances  
Standard Port Size = 4.0"  
Displacement =  
0.522 Gal/Rev  
(1.976 L/Rev)

**BHP = WHP + VHP**

- Operating Specifications:
- 0-600 RPM Range
  - 200 PSI (13.8 bar) Max. Pressure
  - Temperature Range  
-40 °F (-40°C) to  
300 °F (149°C)

Subject to change without notice



# QP1 Series - Positive displacement pumps

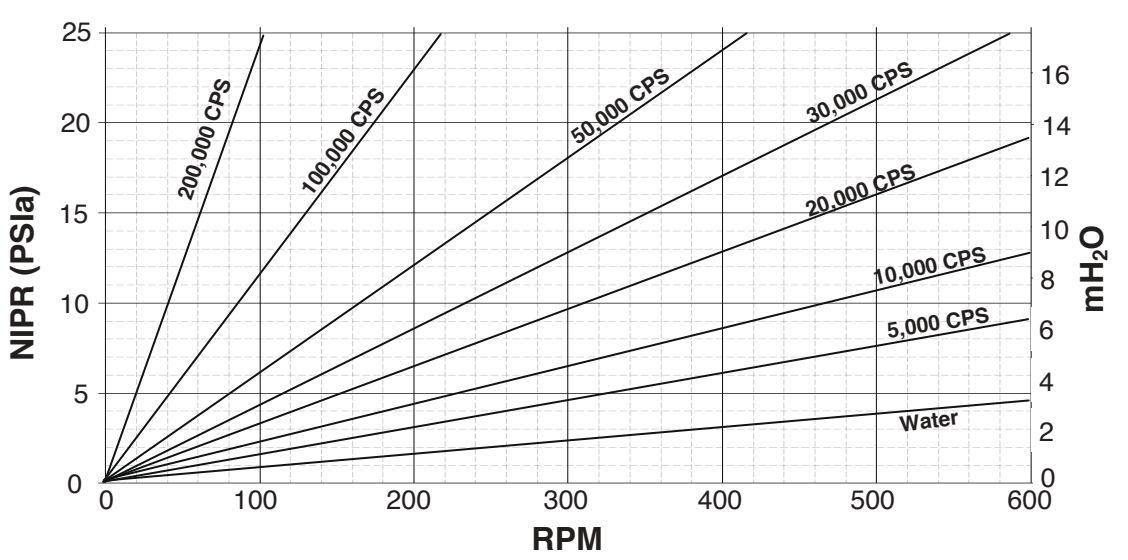
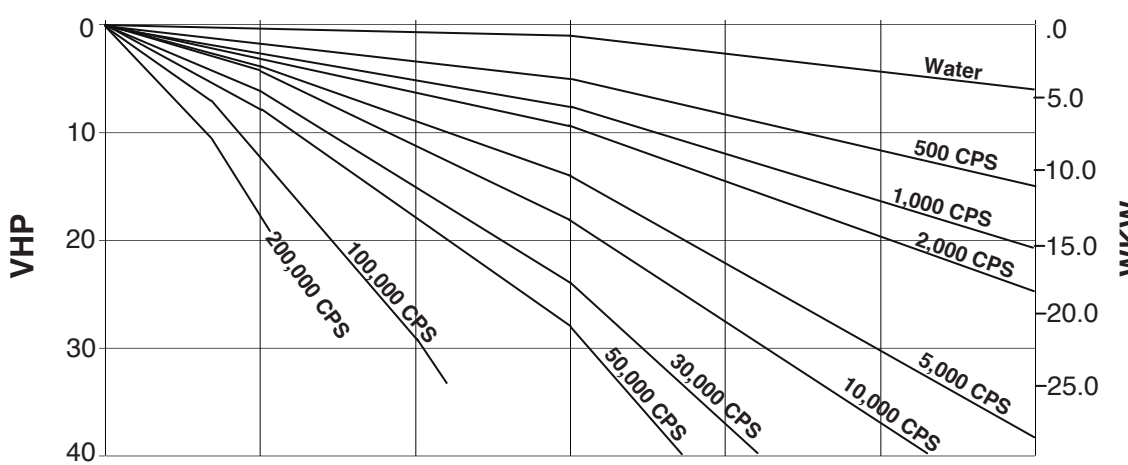
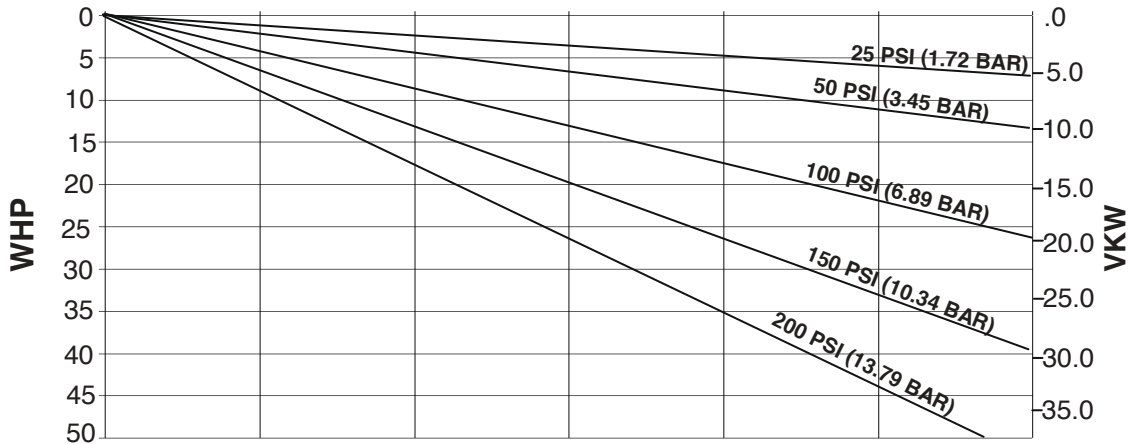
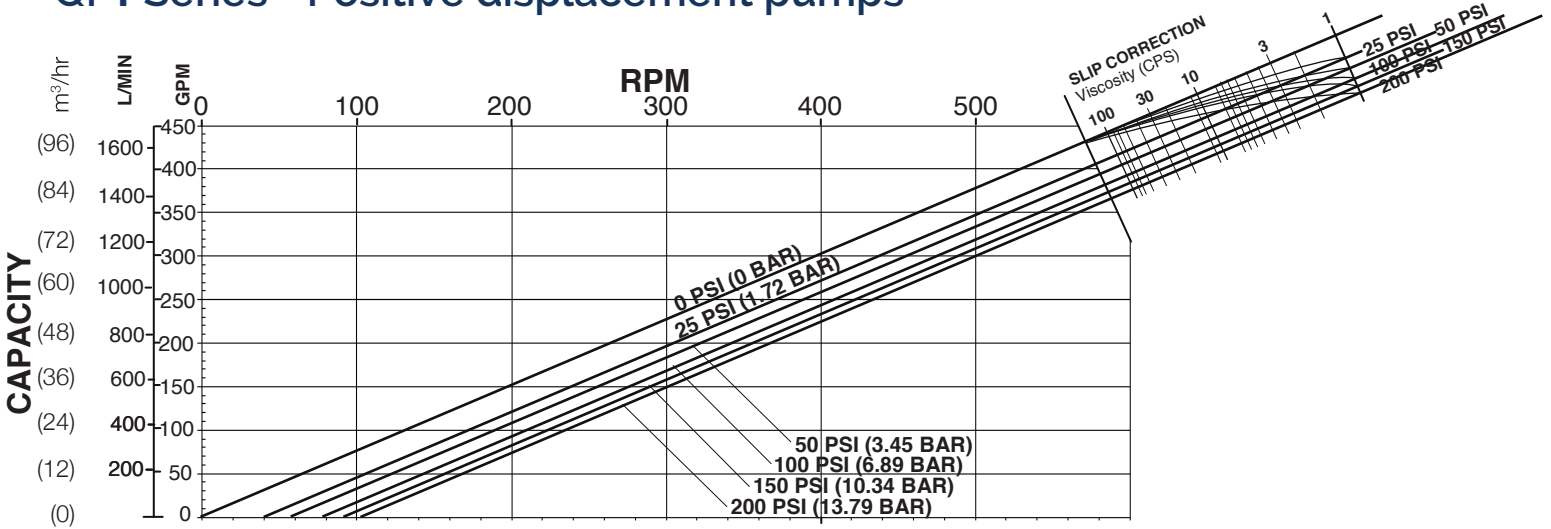

QP Series  
Model QP1-320

Standard Clearances  
Standard Port Size = 6.0"  
Displacement =  
0.754 Gal/Rev  
(2.854 L/Rev)

**BHP = WHP + VHP**

- Operating Specifications:
- 0-600 RPM Range
  - 200 PSI (13.8 bar) Max. Pressure
  - Temperature Range  
-40 °F (-40°C) to  
300 °F (149°C)

Subject to change without notice

# QP2 Series - Positive displacement pumps

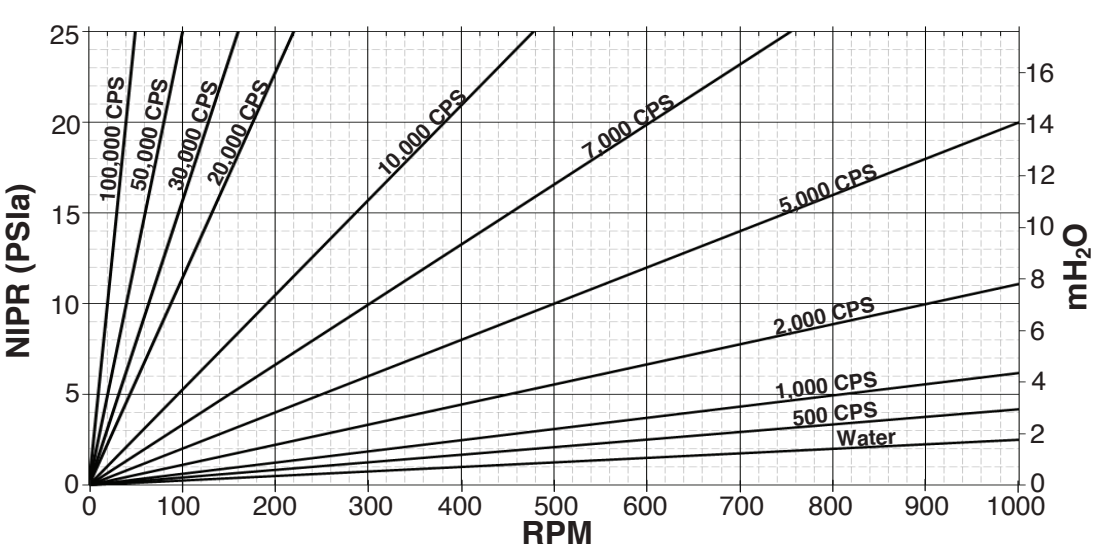
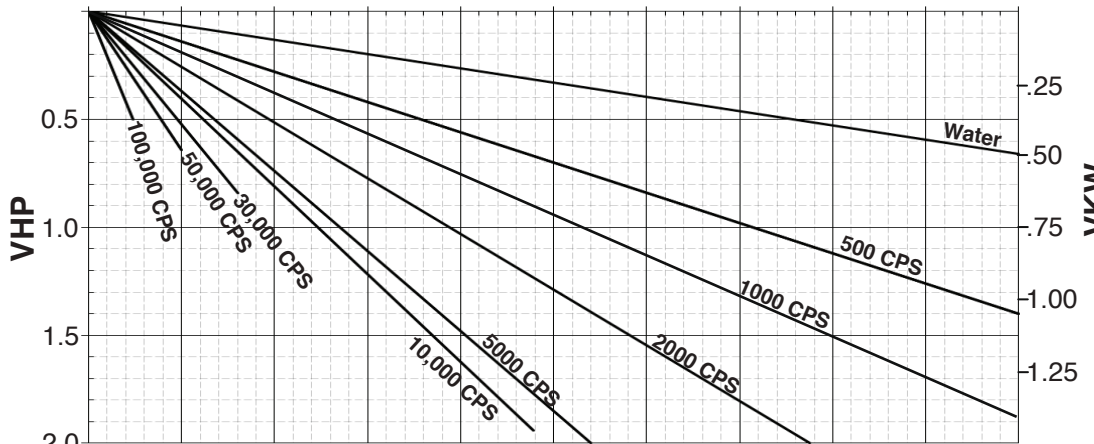
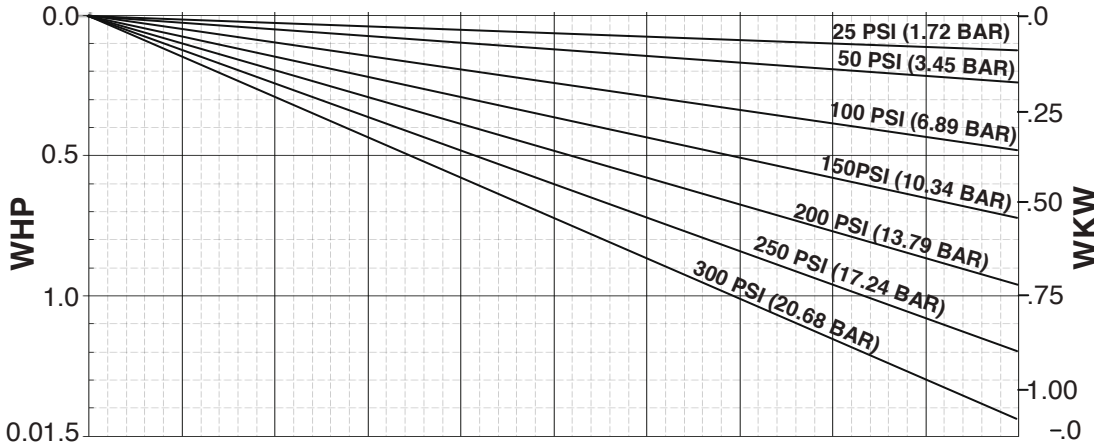
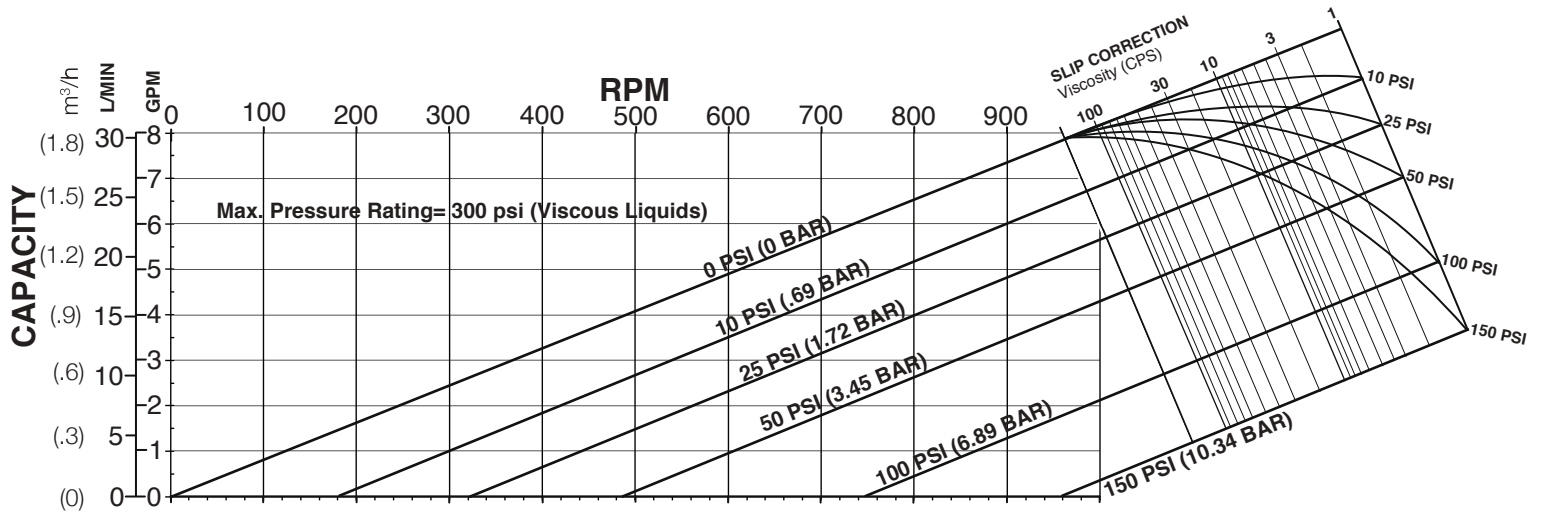

QP Series  
Model QP2-006

Standard Clearances  
Standard Port Size = 1.0"  
Displacement =  
0.0082 Gal/Rev  
(0.031 L/Rev)

**BHP = WHP + VHP**

- Operating Specifications:
- 0-1000 RPM Range
  - 300 PSI (20.7 bar) Max. Pressure
  - Temperature Range  
-40 °F (-40°C) to  
300 °F (149°C)

Subject to change without notice

# QP2 Series - Positive displacement pumps

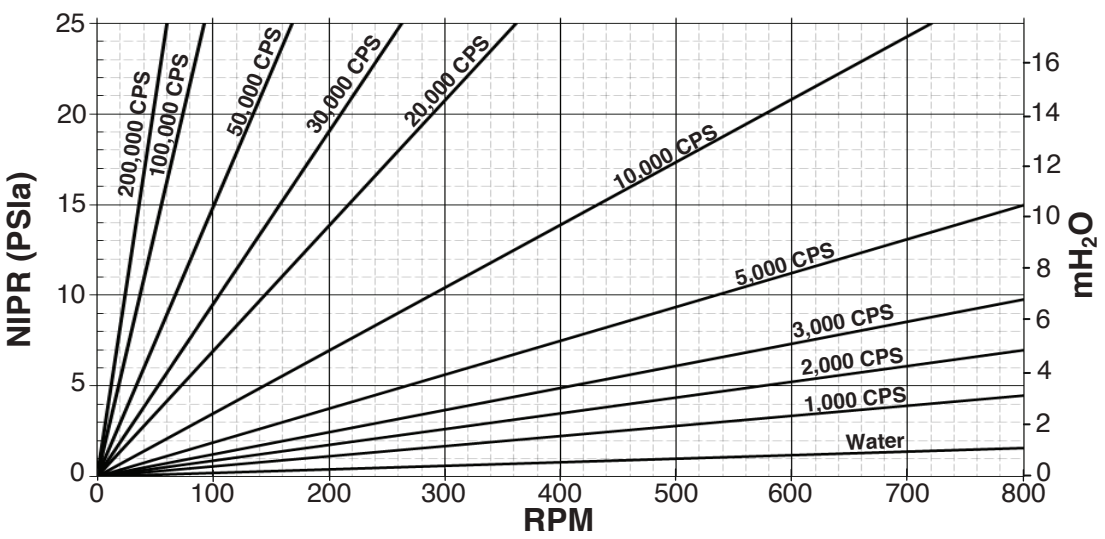
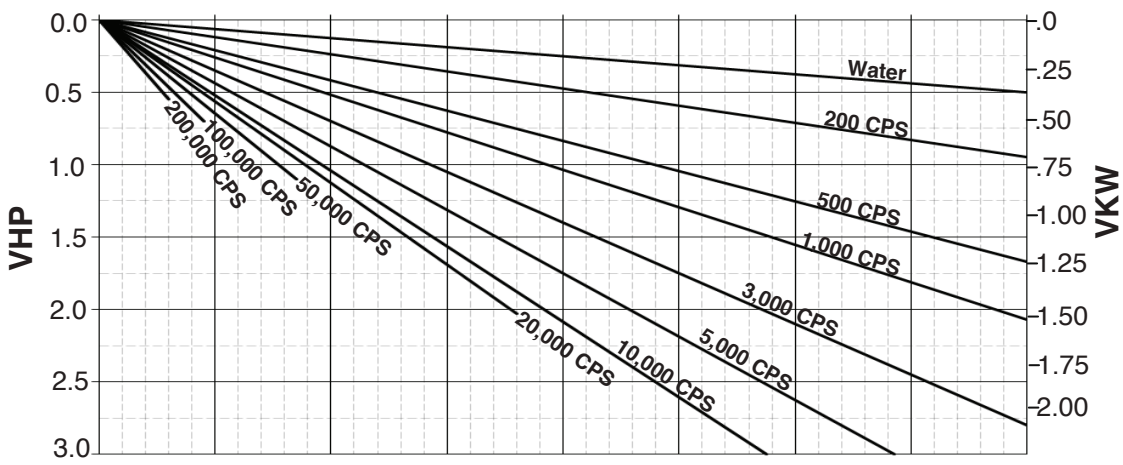
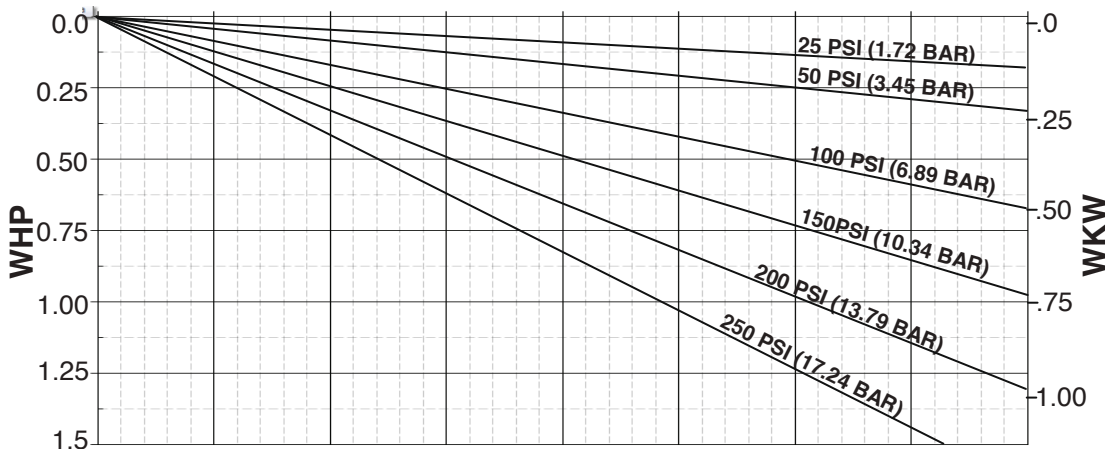
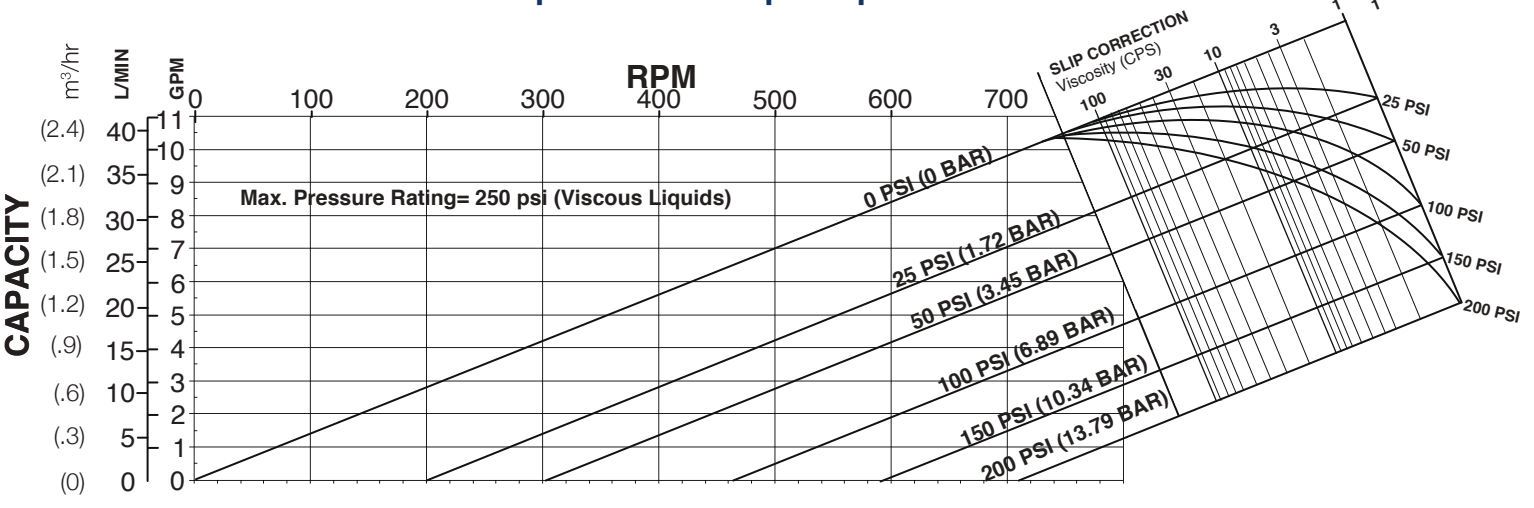

QP Series  
Model QP2-015

Standard Clearances  
Standard Port Size = 1.5"  
Displacement =  
0.014 Gal/Rev  
(0.054 L/Rev)

**BHP = WHP + VHP**

- Operating Specifications:
- 0-800 RPM Range
  - 250 PSI (17.2 bar) Max. Pressure
  - Temperature Range  
-40 °F (-40°C) to  
300 °F (149°C)

Subject to change without notice

# QP2 Series - Positive displacement pumps

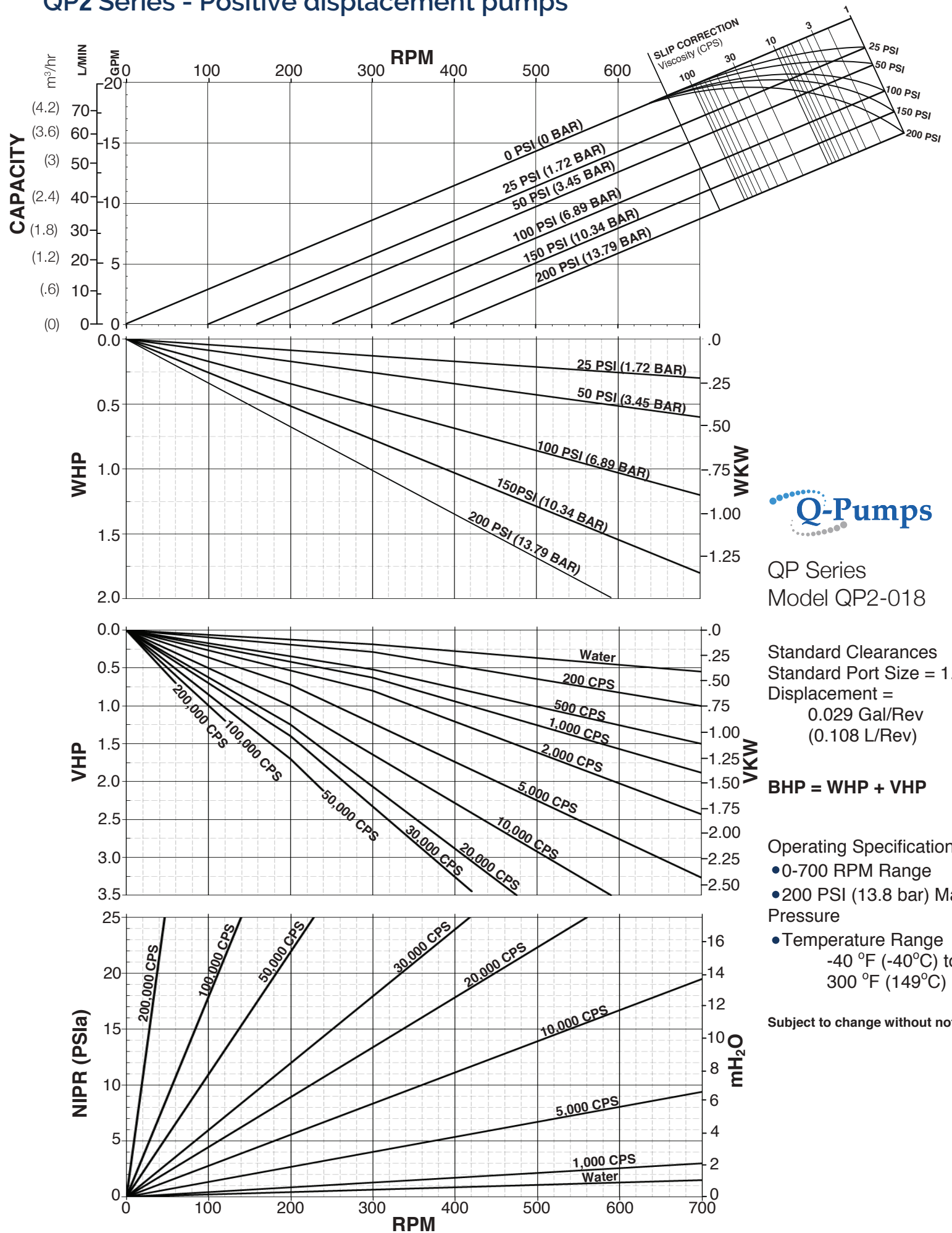

QP Series  
Model QP2-018

Standard Clearances  
Standard Port Size = 1.5"  
Displacement =  
0.029 Gal/Rev  
(0.108 L/Rev)

**BHP = WHP + VHP**

- Operating Specifications:
- 0-700 RPM Range
  - 200 PSI (13.8 bar) Max. Pressure
  - Temperature Range  
-40 °F (-40°C) to  
300 °F (149°C)

Subject to change without notice

# QP2 Series - Positive displacement pumps

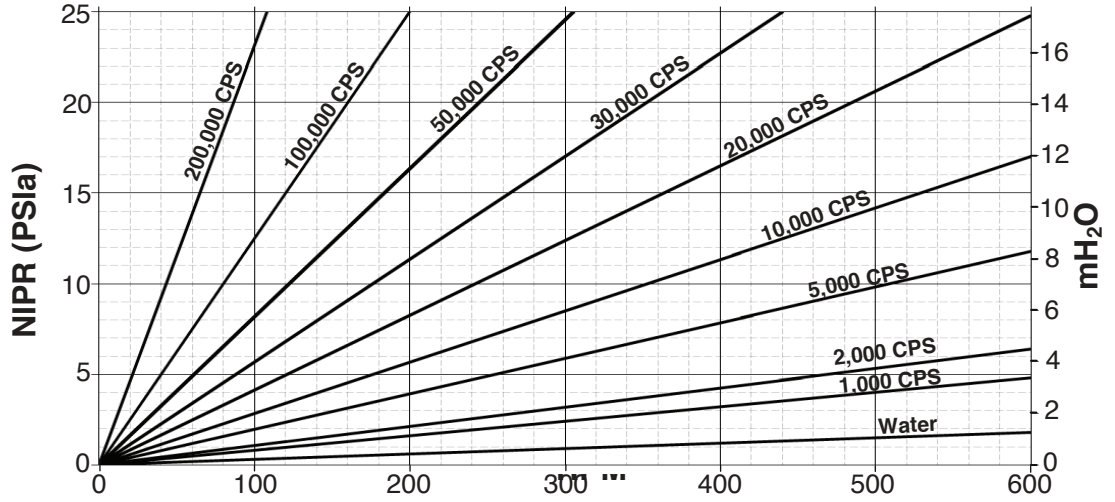
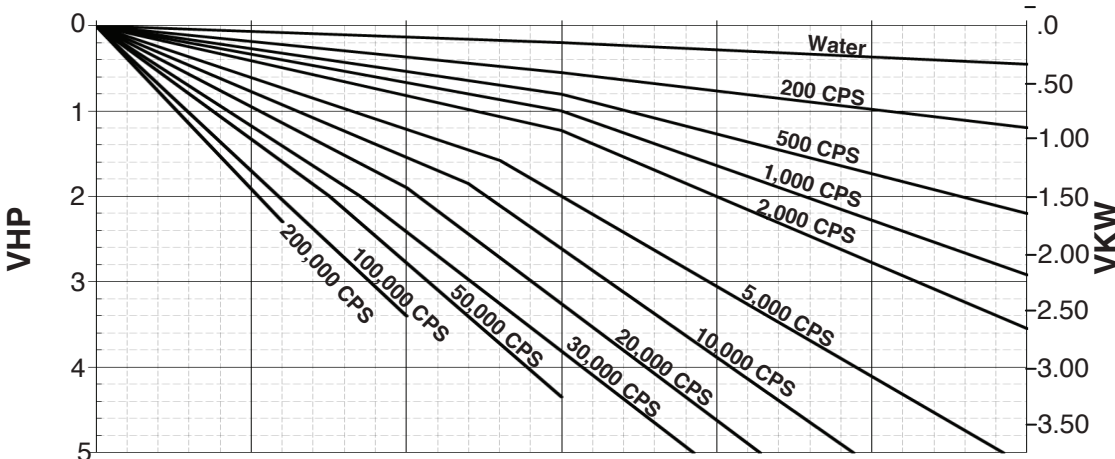
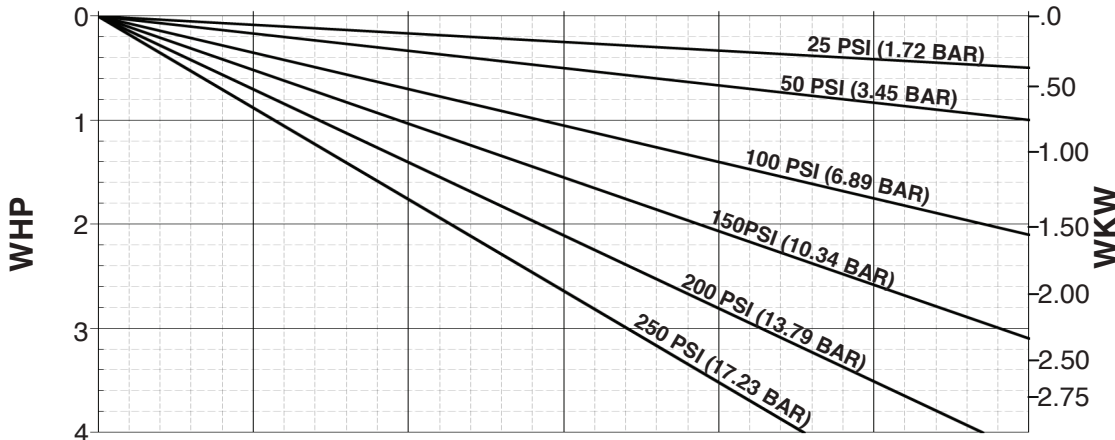
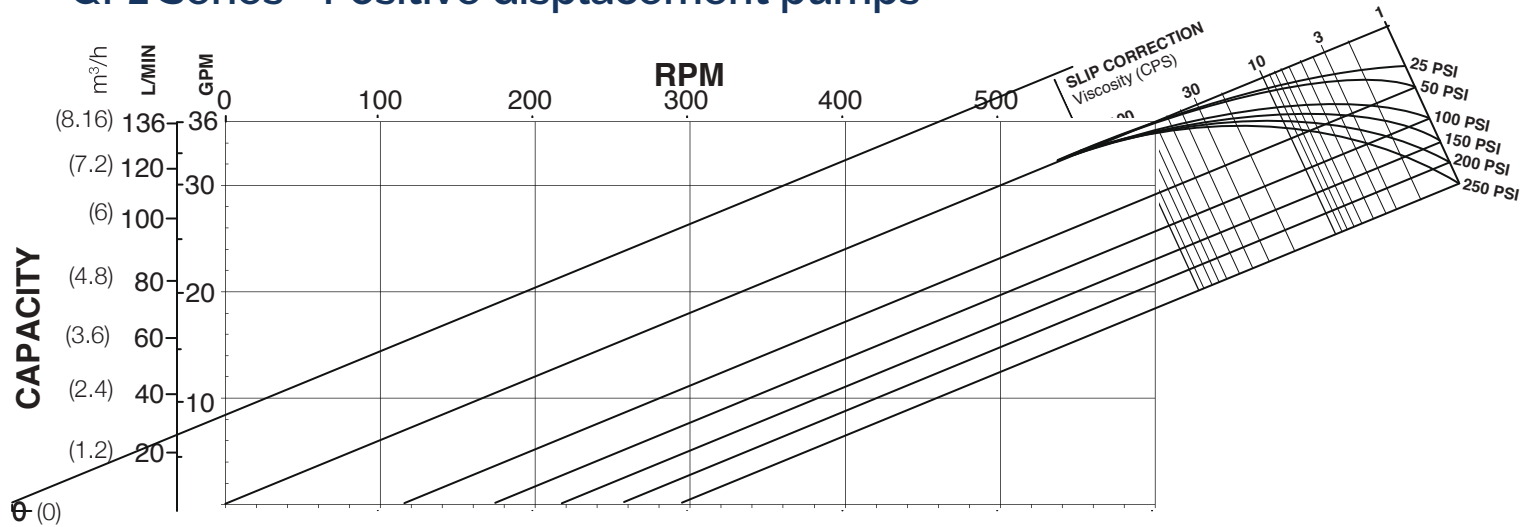

QP Series  
Model QP2-030

Standard Clearances  
Standard Port Size = 1.5"  
Displacement =  
0.060 Gal/Rev  
(0.227 L/Rev)

**BHP = WHP + VHP**

- Operating Specifications:
- 0-600 RPM Range
  - 250 PSI (17.2 bar) Max. Pressure
  - Temperature Range  
-40 °F (-40°C) to  
300 °F (149°C)

Subject to change without notice

# QP2 Series - Positive displacement pumps

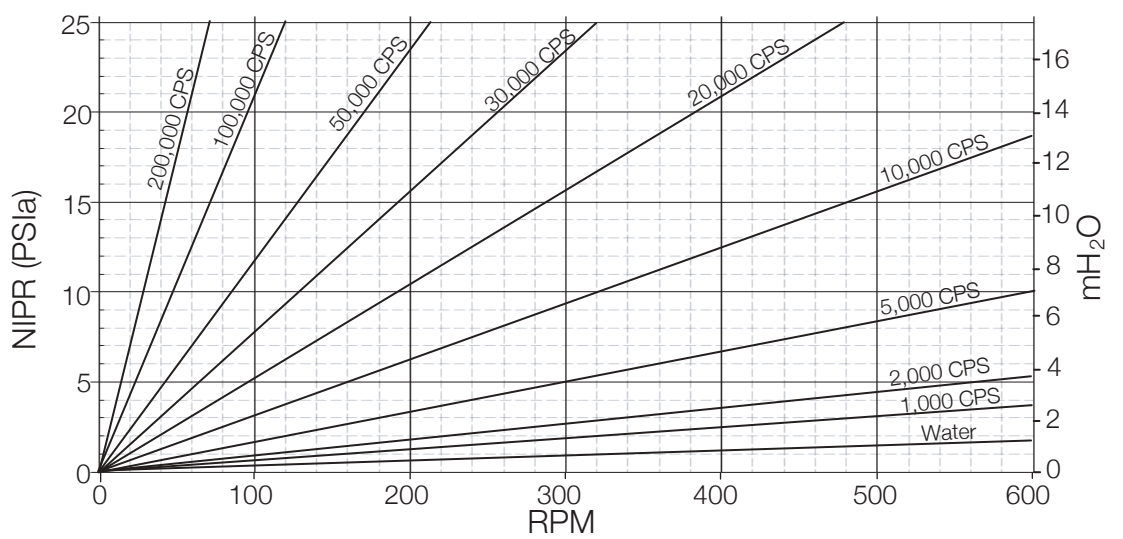
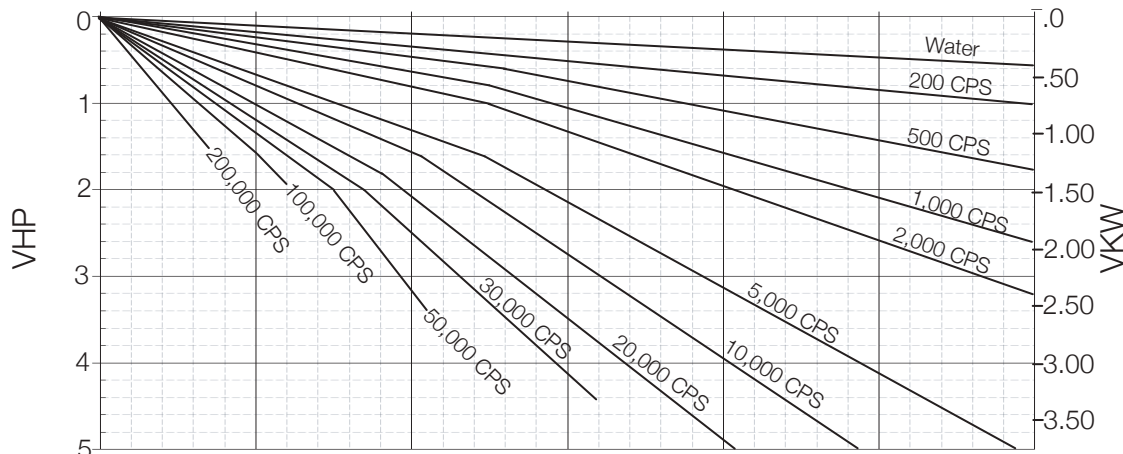
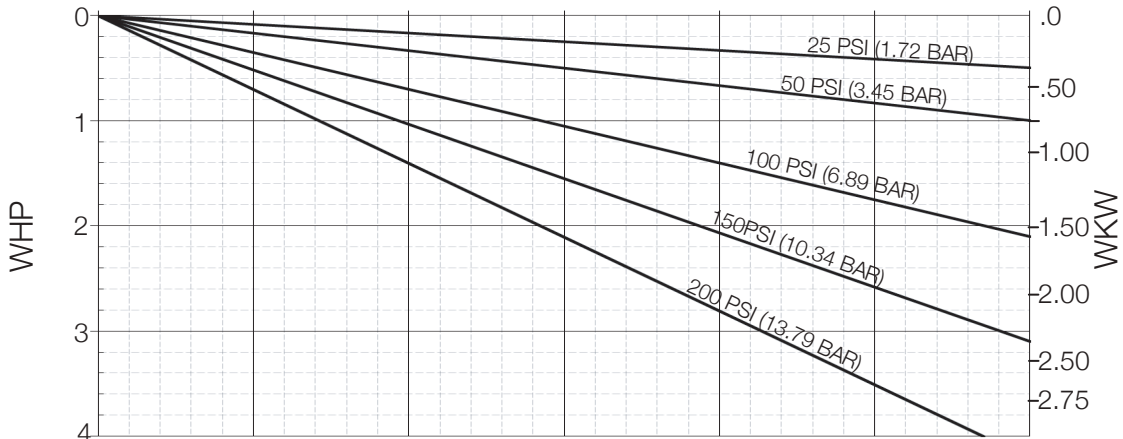
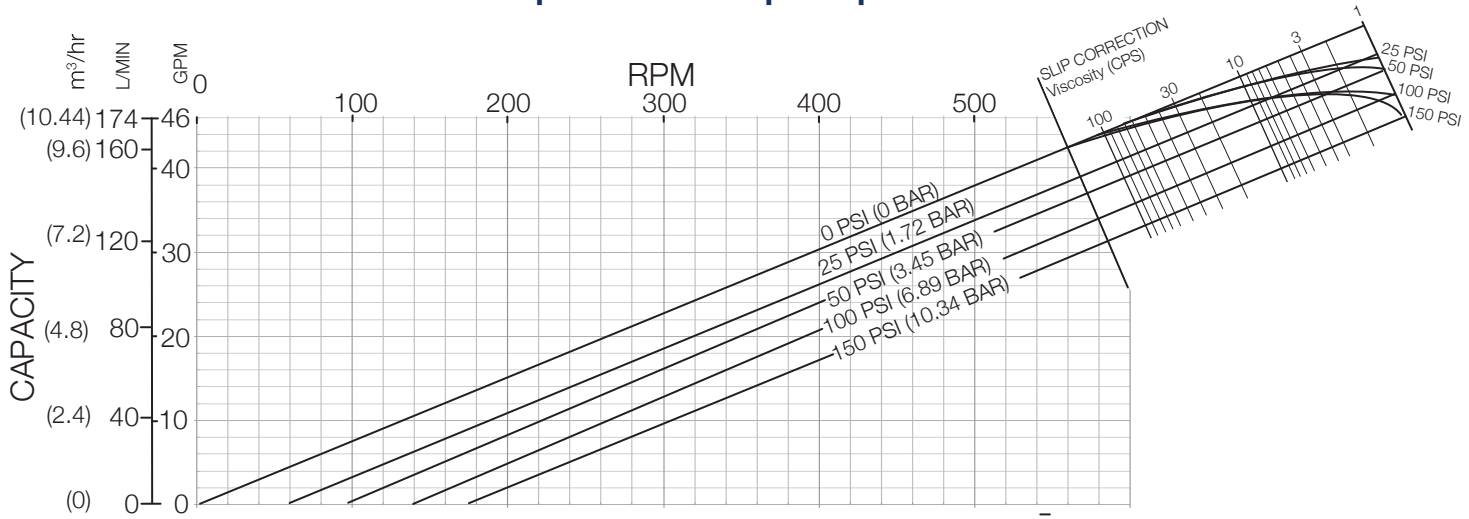

QP Series  
Model QP2-040

Standard Clearances  
Standard Port Size = 2.0"  
Displacement =  
0.076Gal/Rev  
(0.288 L/Rev)

**BHP = WHP + VHP**

- Operating Specifications:
- 0-600 RPM Range
  - 150 PSI (10.3 bar) Max. Pressure
  - Temperature Range  
-40 °F (-40°C) to  
300 °F (149°C)

Subject to change without notice

# QP2 Series - Positive displacement pumps

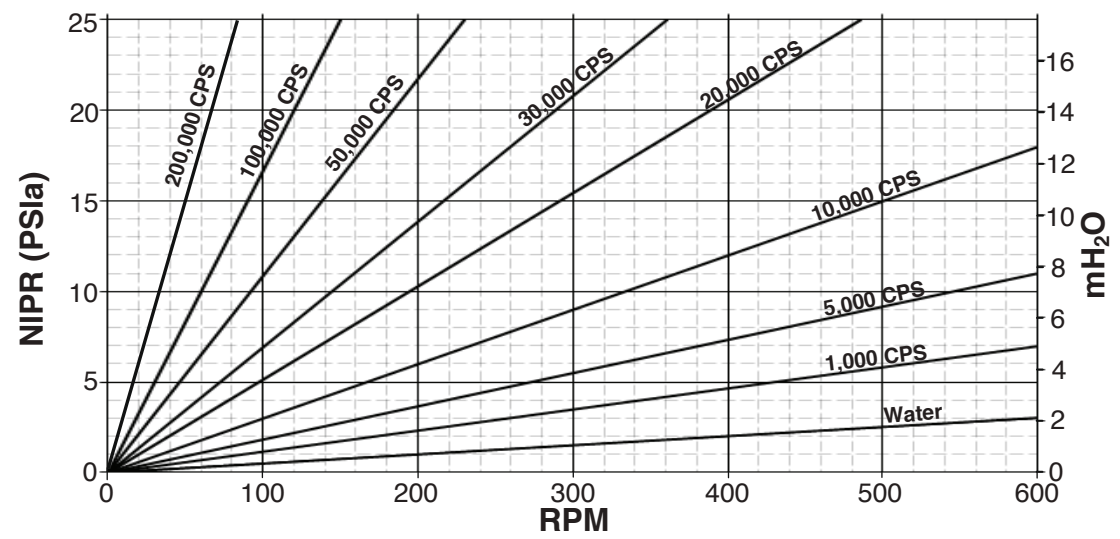
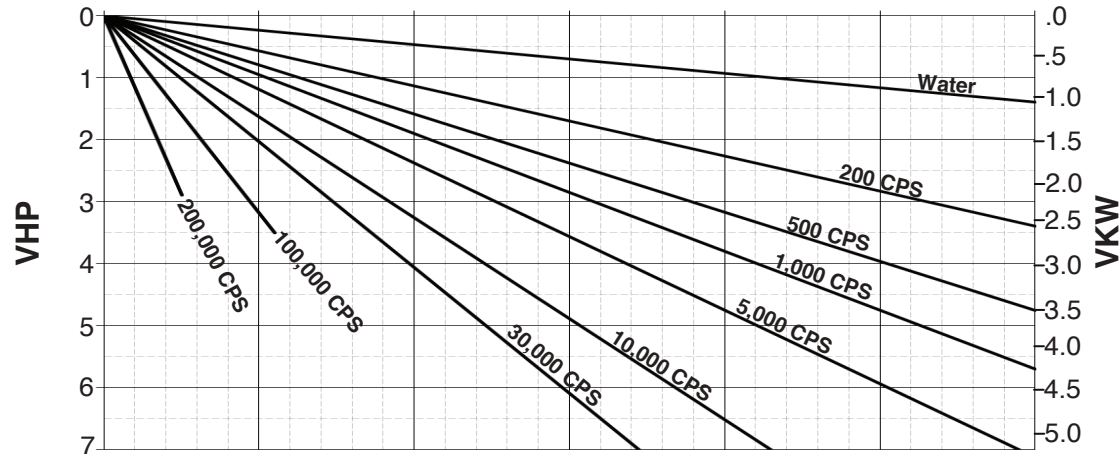
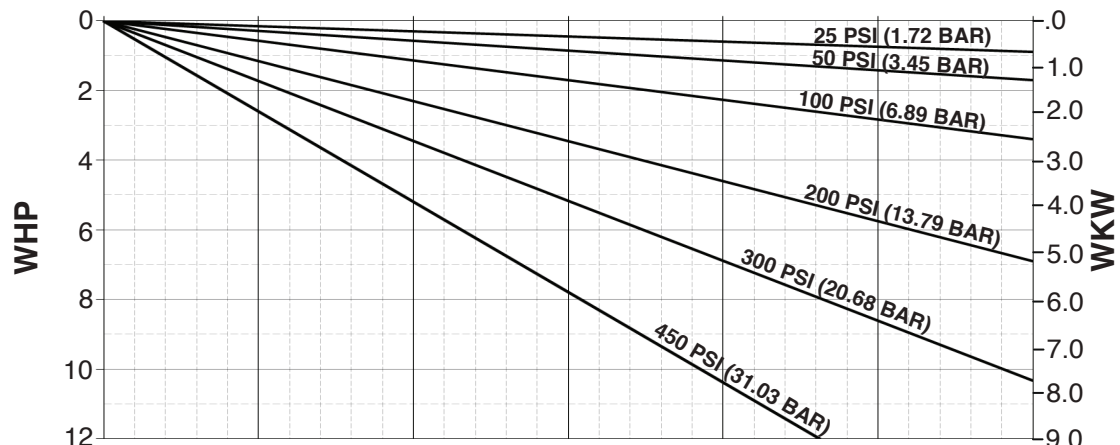
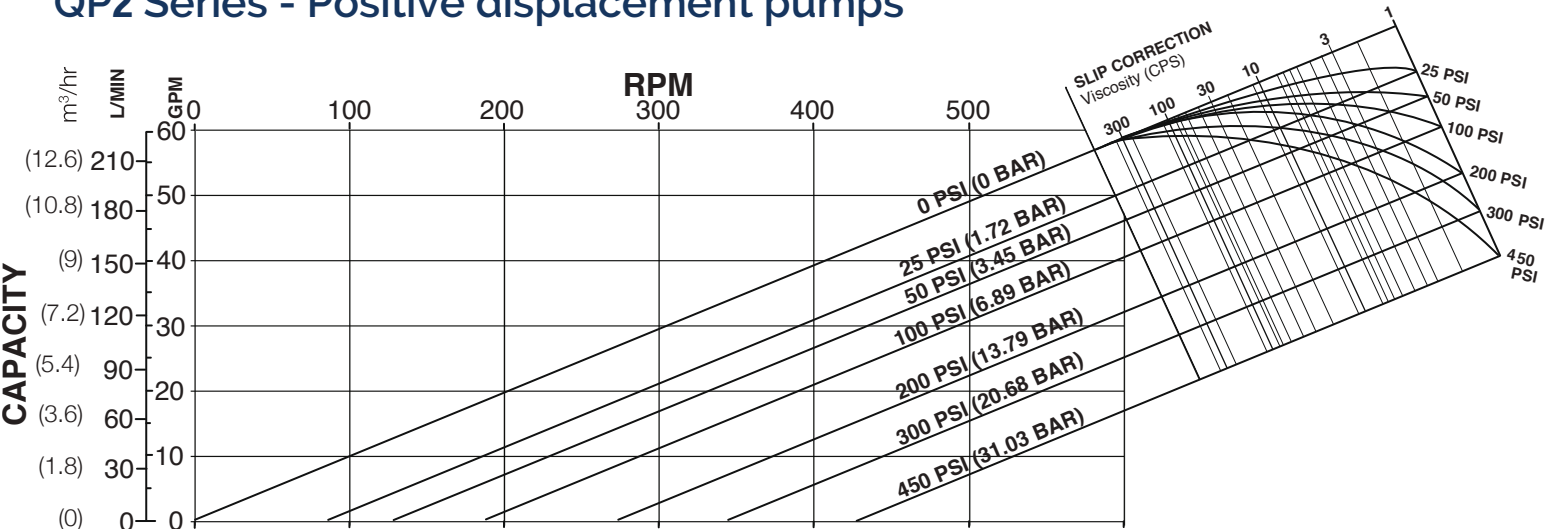

QP Series  
Model QP2-045

Standard Clearances  
Standard Port Size = 2.0"  
Displacement =  
0.098 Gal/Rev  
(0.371 L/Rev)

**BHP = WHP + VHP**

- Operating Specifications:
- 0-600 RPM Range
  - 450 PSI (31.0 bar) Max. Pressure
  - Temperature Range  
-40 °F (-40°C) to  
300 °F (149°C)

Subject to change without notice

# QP2 Series - Positive displacement pumps

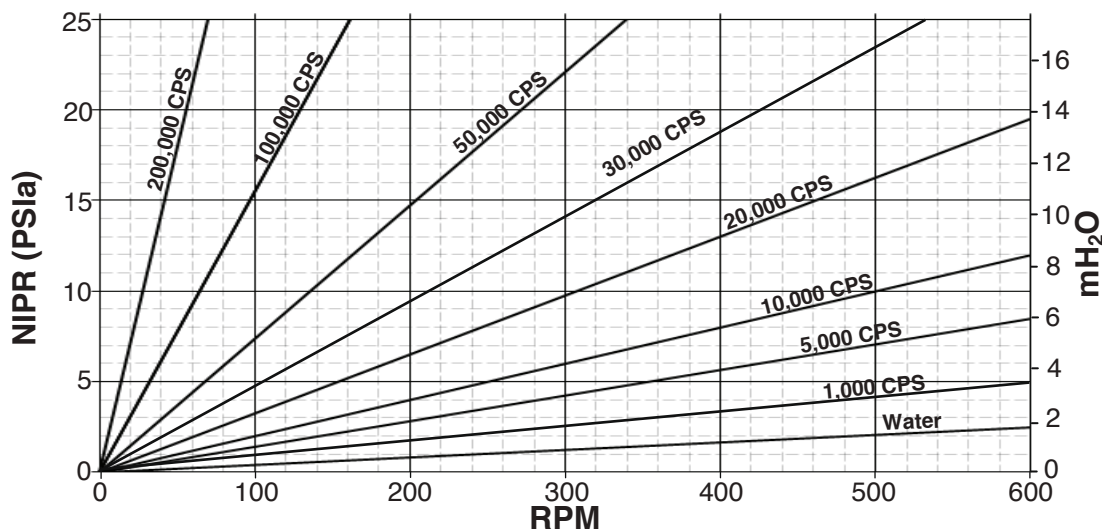
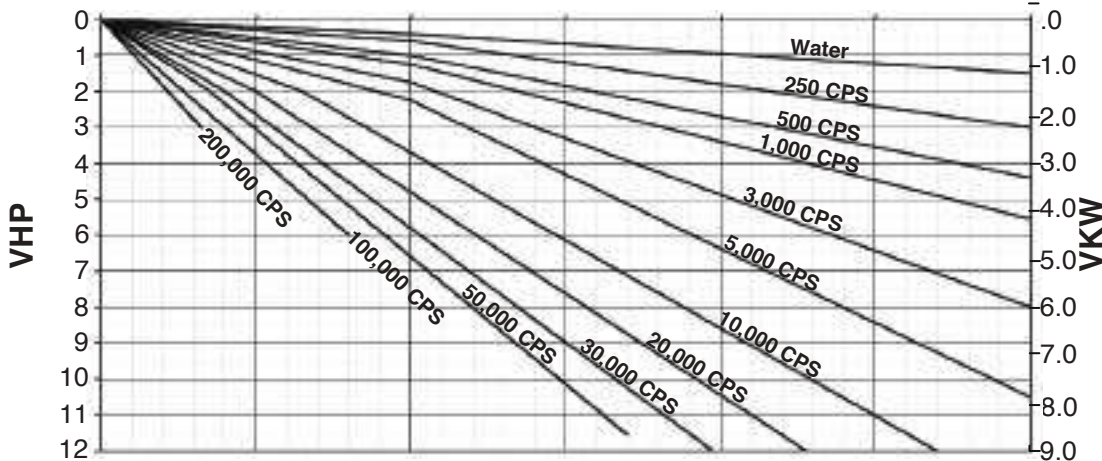
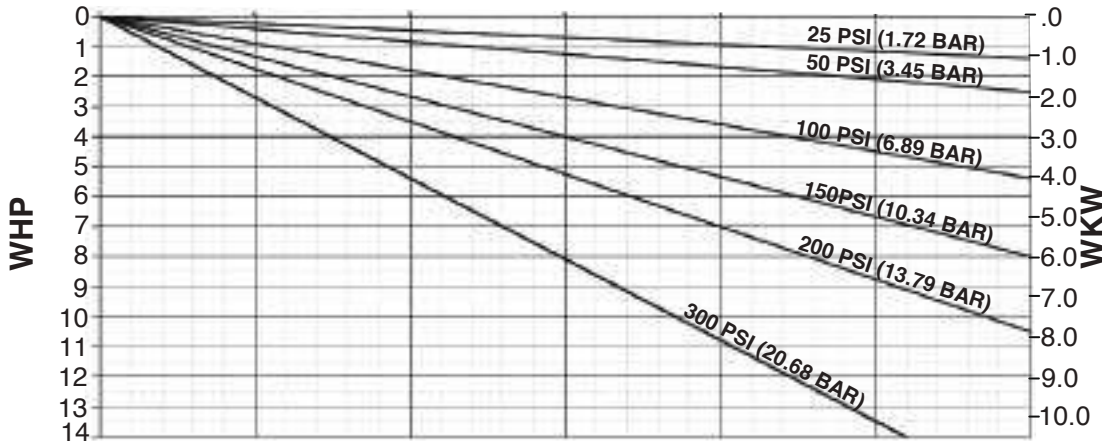
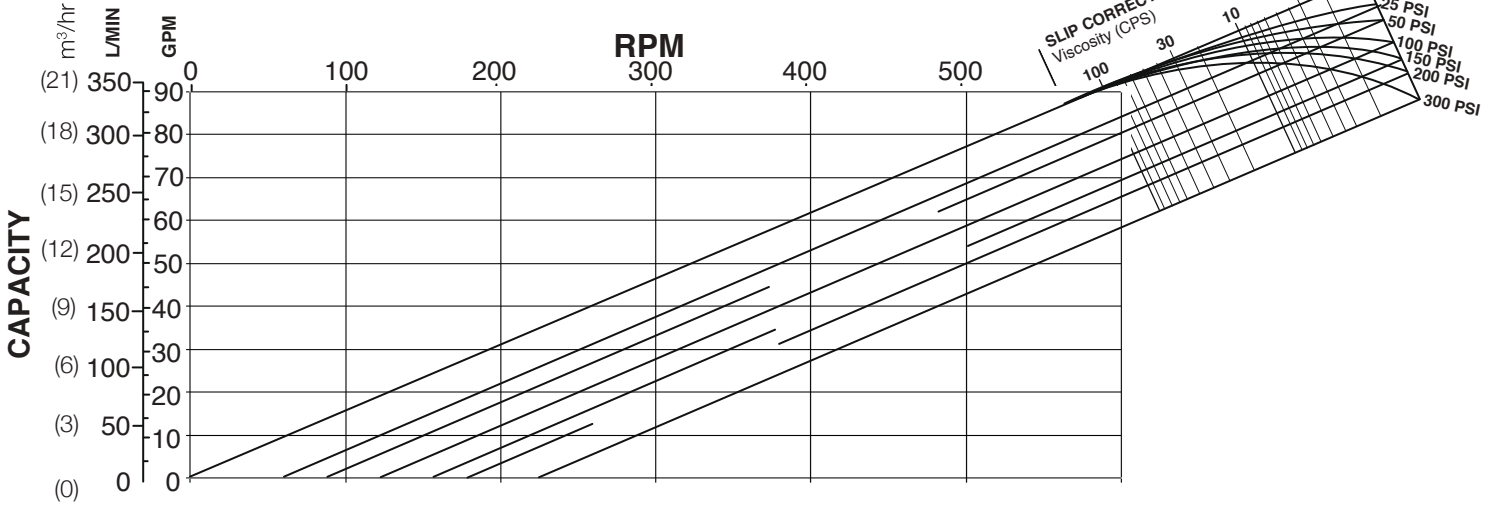

QP Series  
Model QP2-060

Standard Clearances  
Standard Port Size = 2.5"  
Displacement =  
0.153 Gal/Rev  
(0.579 L/Rev)

**BHP = WHP + VHP**

- Operating Specifications:
- 0-600 RPM Range
  - 300 PSI (20.7 bar) Max. Pressure
  - Temperature Range  
-40 °F (-40°C) to  
300 °F (149°C)

Subject to change without notice



# QP2 Series - Positive displacement pumps

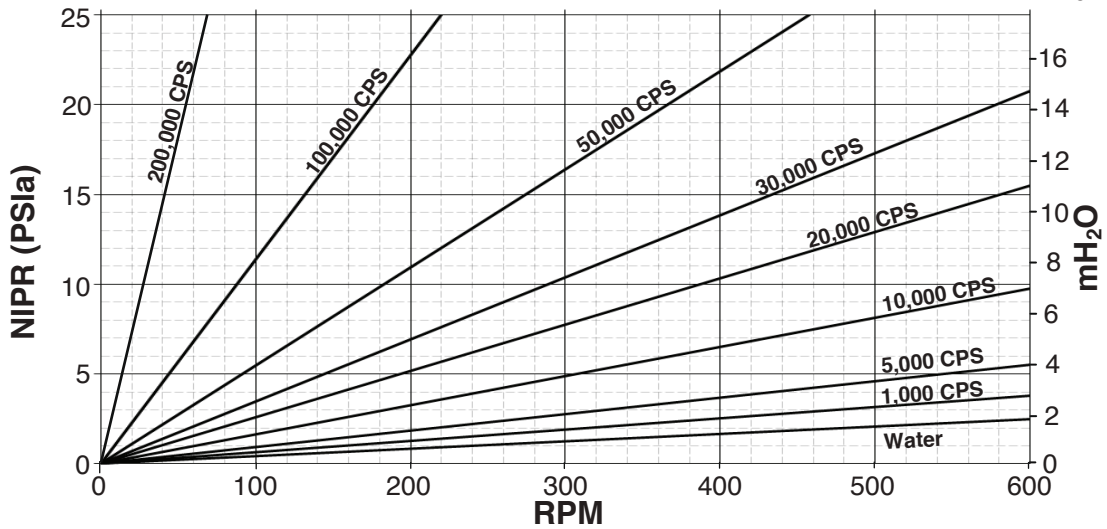
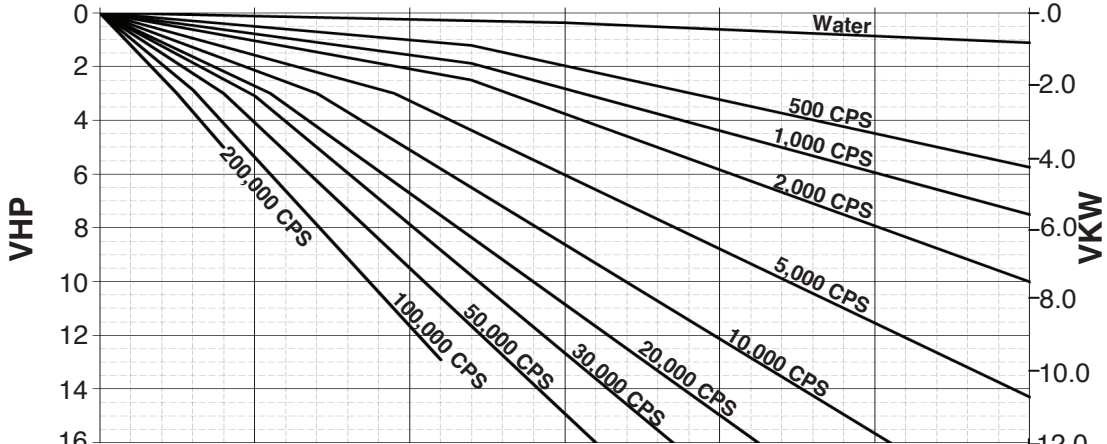
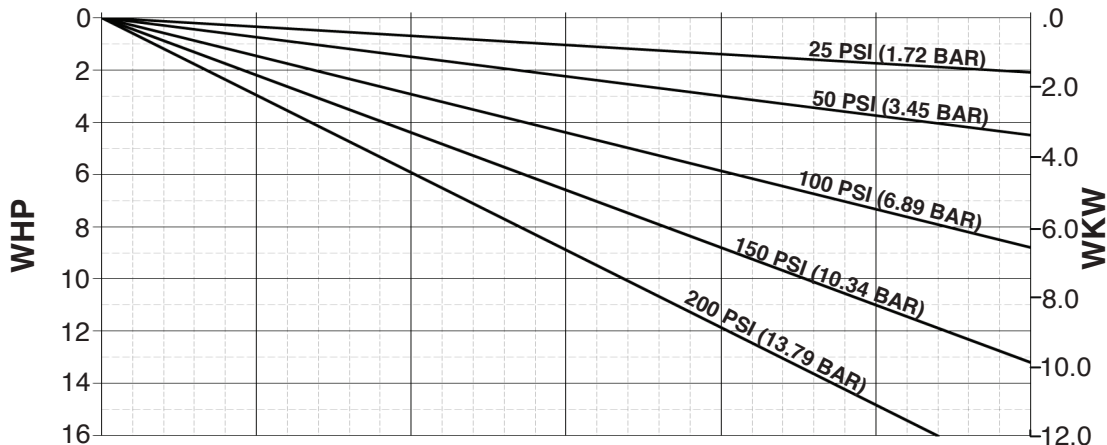
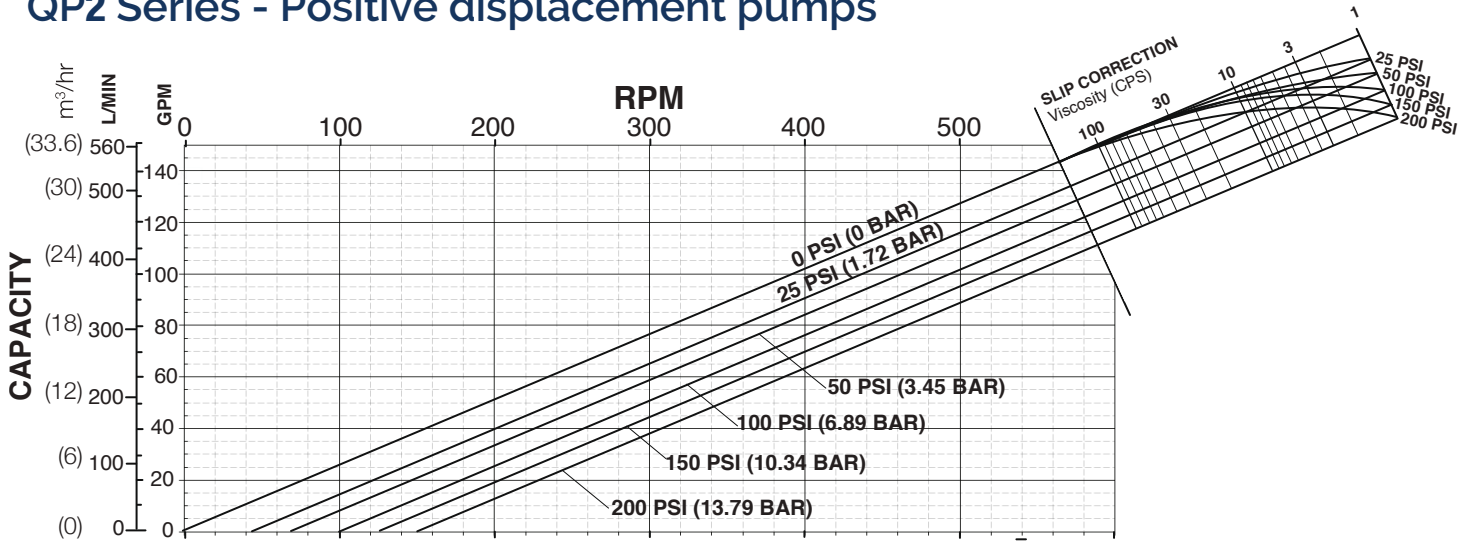

QP Series  
Model QP2-130

Standard Clearances  
Standard Port Size = 3.0"  
Displacement =  
0.253 Gal/Rev  
(0.958 L/Rev)

**BHP = WHP + VHP**

- Operating Specifications:
- 0-600 RPM Range
  - 200 PSI (13.8 bar) Max. Pressure
  - Temperature Range  
-40 °F (-40°C) to  
300 °F (149°C)

Subject to change without notice

# QP2 Series - Positive displacement pumps

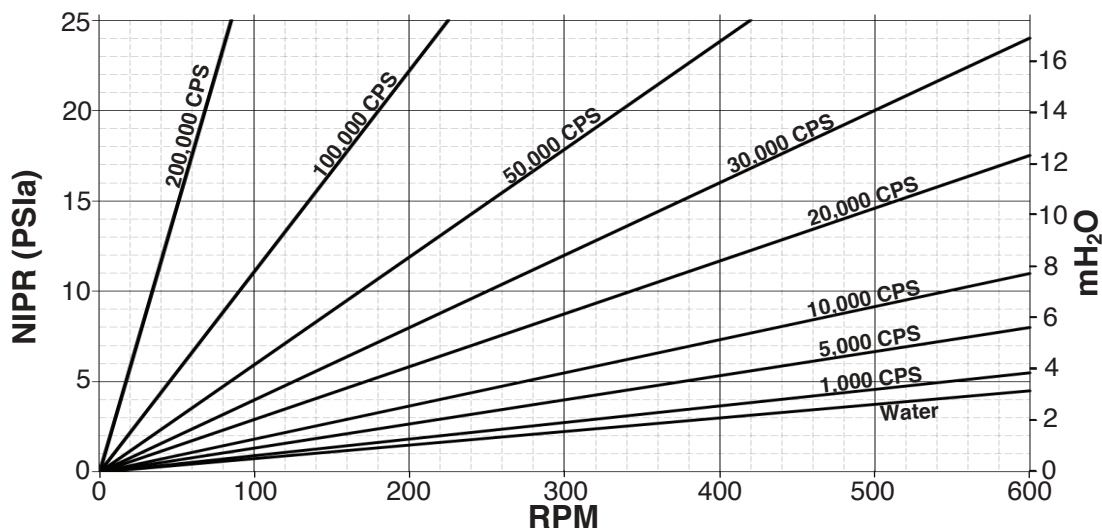
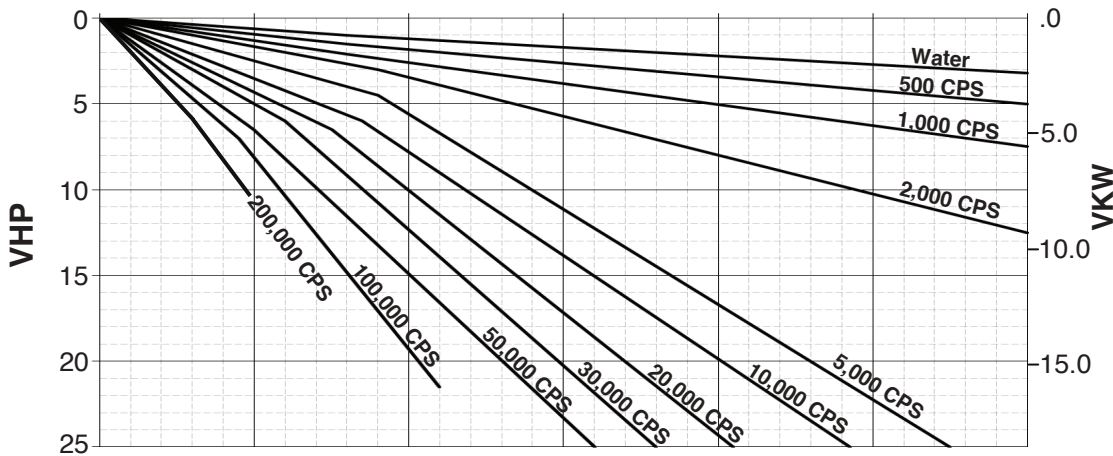
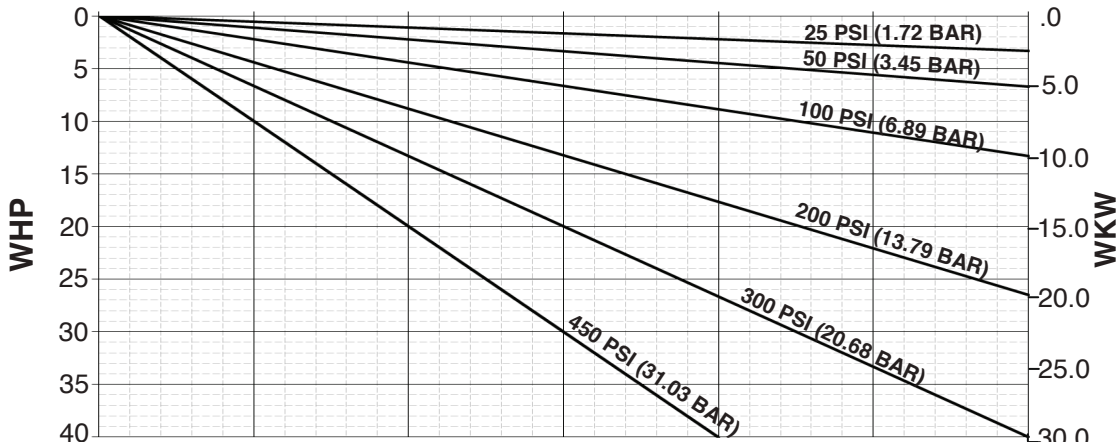
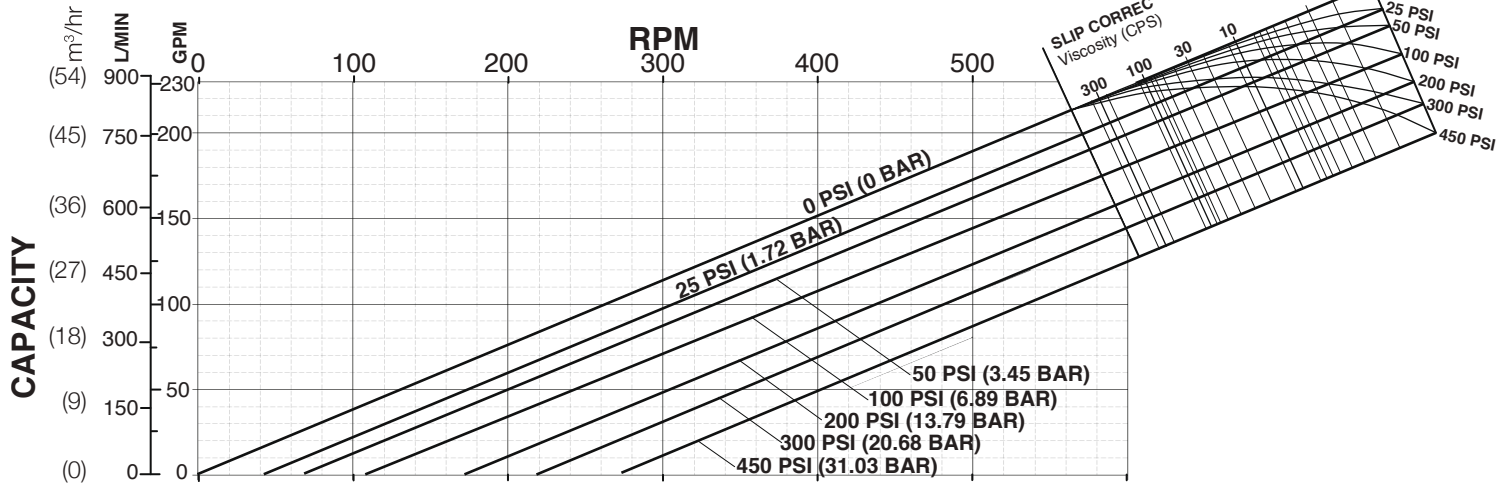

QP Series  
Model QP2-180

Standard Clearances  
Standard Port Size = 3.0"  
Displacement =  
0.380 Gal/Rev  
(1.438 L/Rev)

**BHP = WHP + VHP**

- Operating Specifications:
- 0-600 RPM Range
  - 450 PSI (31.0 bar) Max. Pressure
  - Temperature Range  
-40 °F (-40°C) to  
300 °F (149°C)

Subject to change without notice

# QP2 Series - Positive displacement pumps

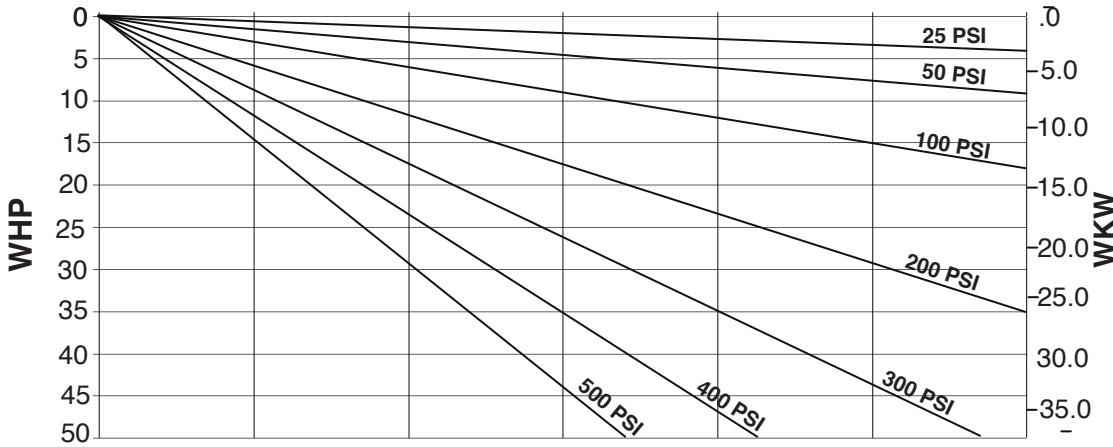
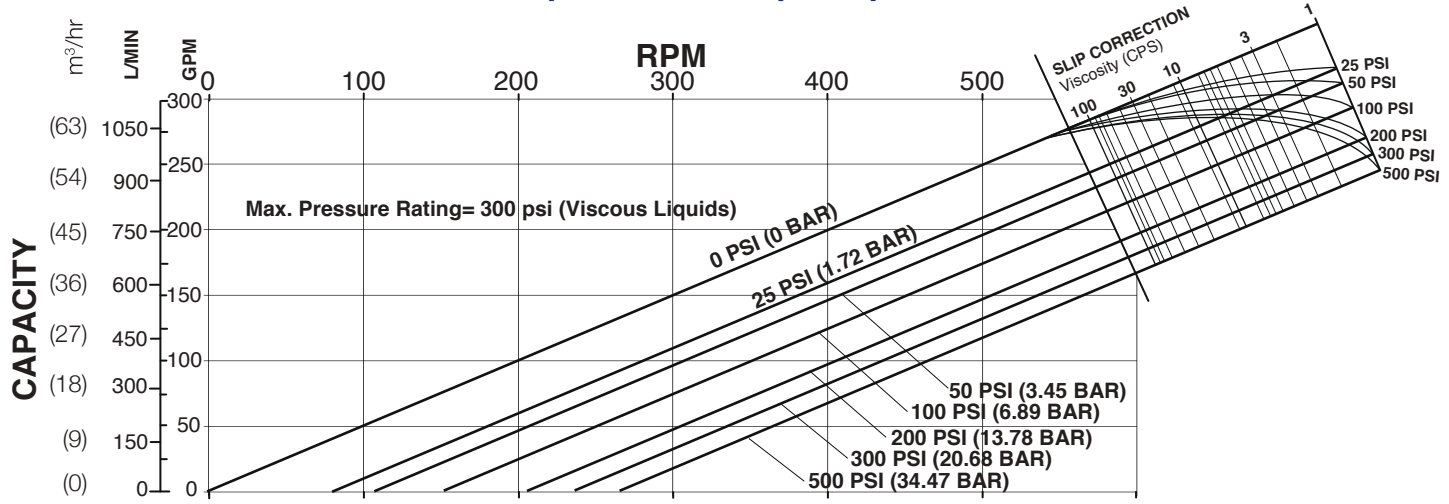

QP Series  
Model QP2-210

Standard Clearances  
Standard Port Size = 4.0"  
Displacement =  
0.502 Gal/Rev  
(1.900 L/Rev)

**BHP = WHP + VHP**

- Operating Specifications:
- 0-600 RPM Range
  - 500 PSI (34.48 bar) Max. Pressure
  - Temperature Range  
-40 °F (-40°C) to  
300 °F (149°C)

Subject to change without notice

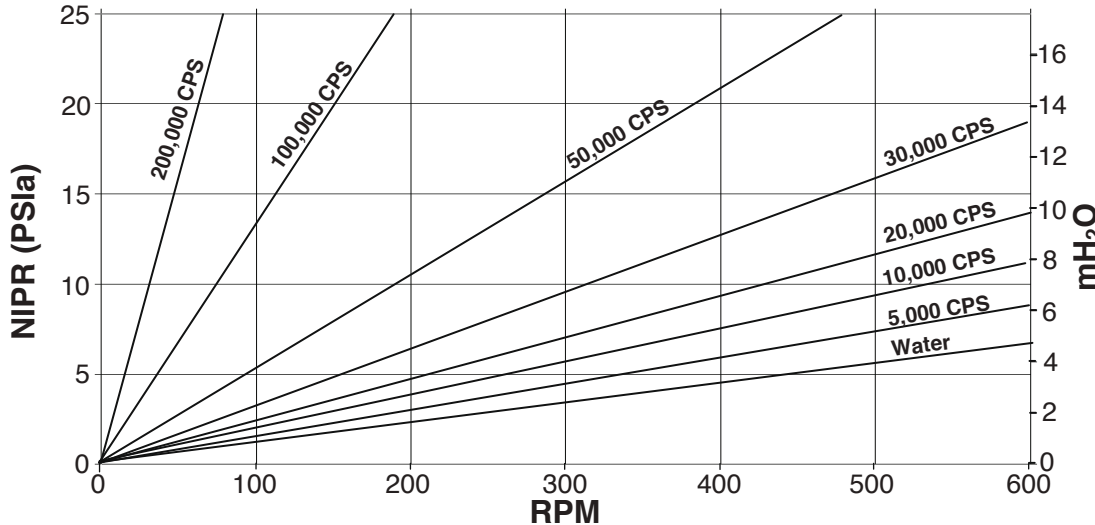
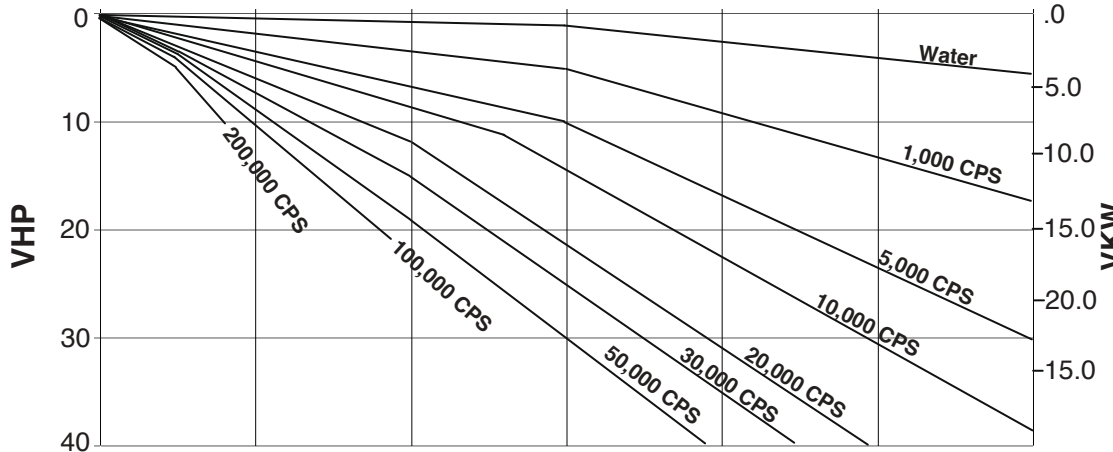

# QP2 Series - Positive displacement pumps

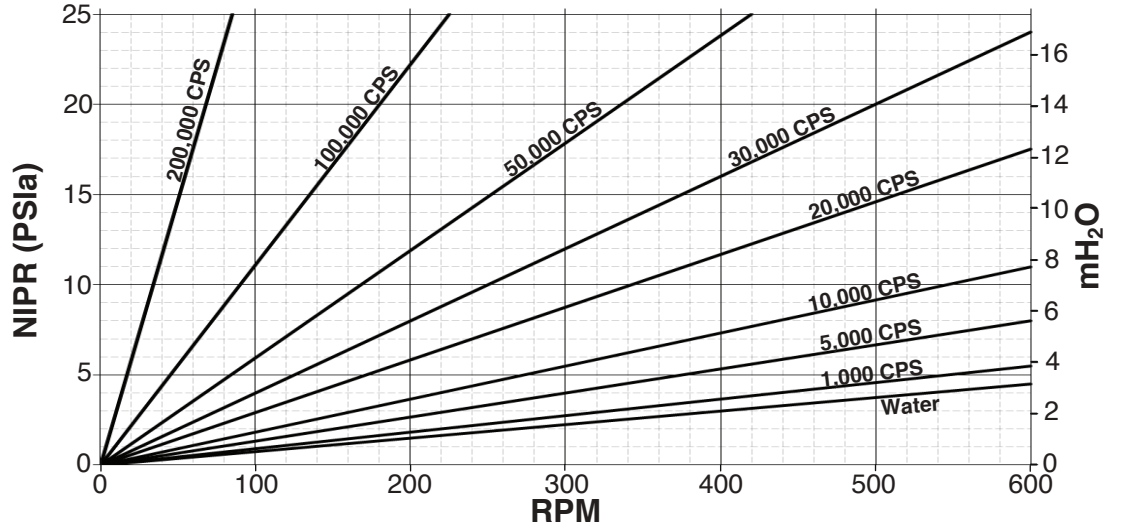
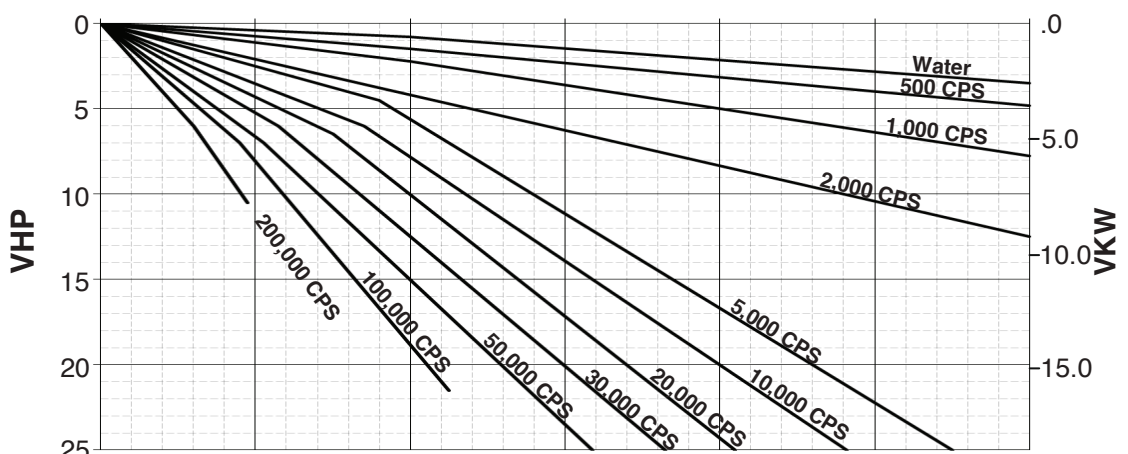
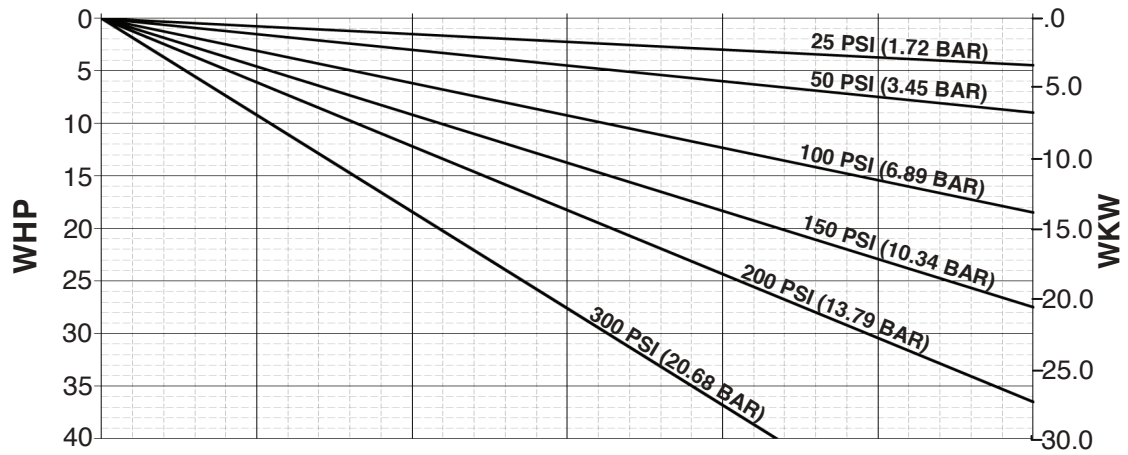
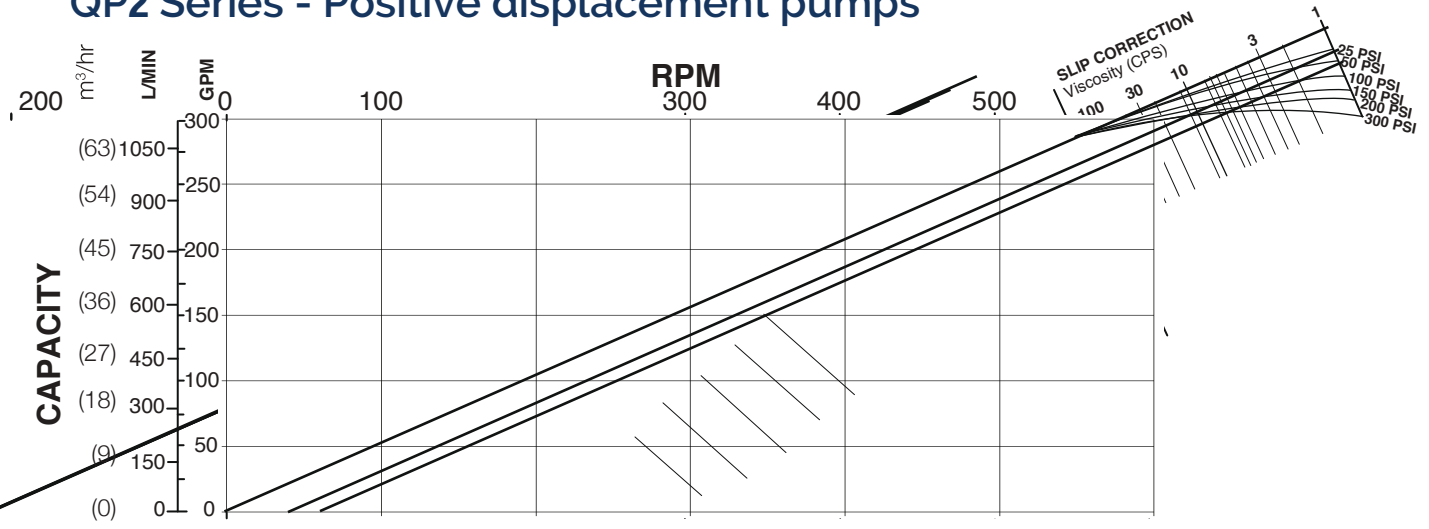

QP Series  
Model QP2- 220

Standard Clearances  
Standard Port Size = 4.0"  
Displacement =  
0.521 Gal/Rev  
(1.972 L/Rev)

**BHP = WHP + VHP**

- Operating Specifications:
- 0-600 RPM Range
  - 300 PSI (20.68 bar) Max. Pressure
  - Temperature Range -40 °F (-40°C) to 300 °F (149°C)

Subject to change without notice

# QP2 Series - Positive displacement pumps

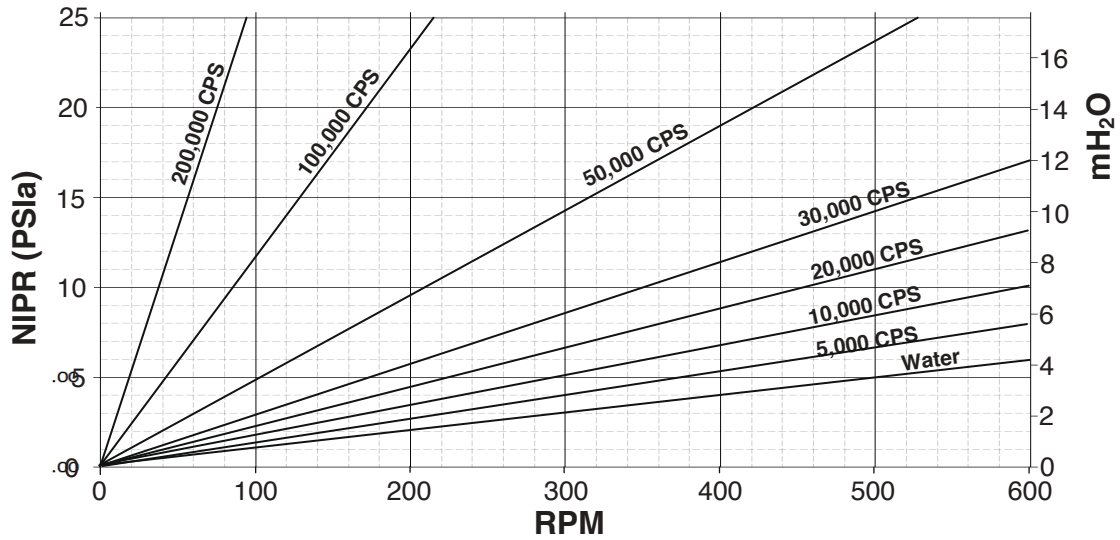
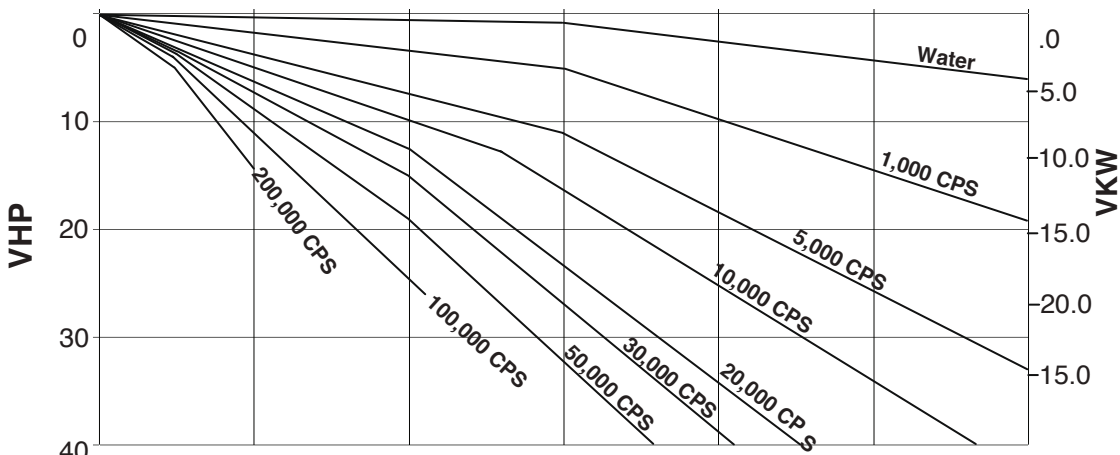
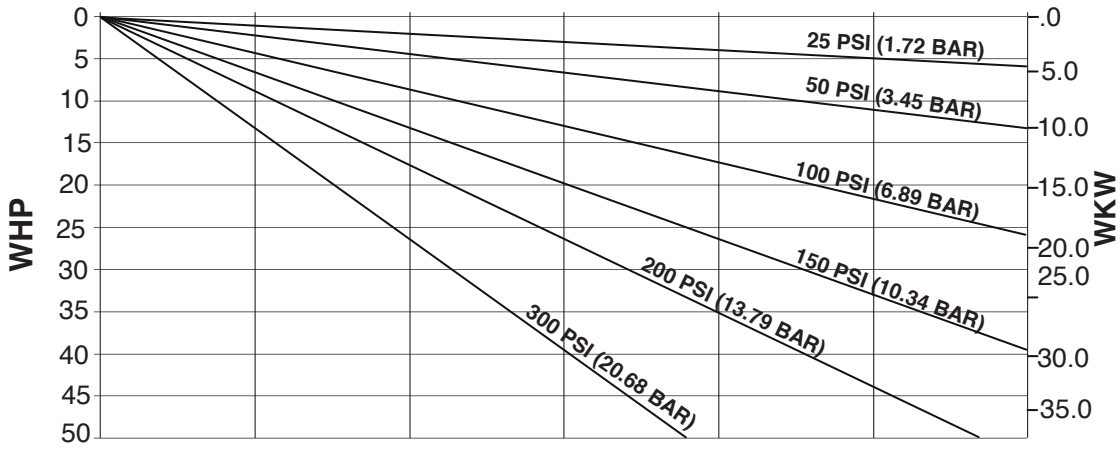
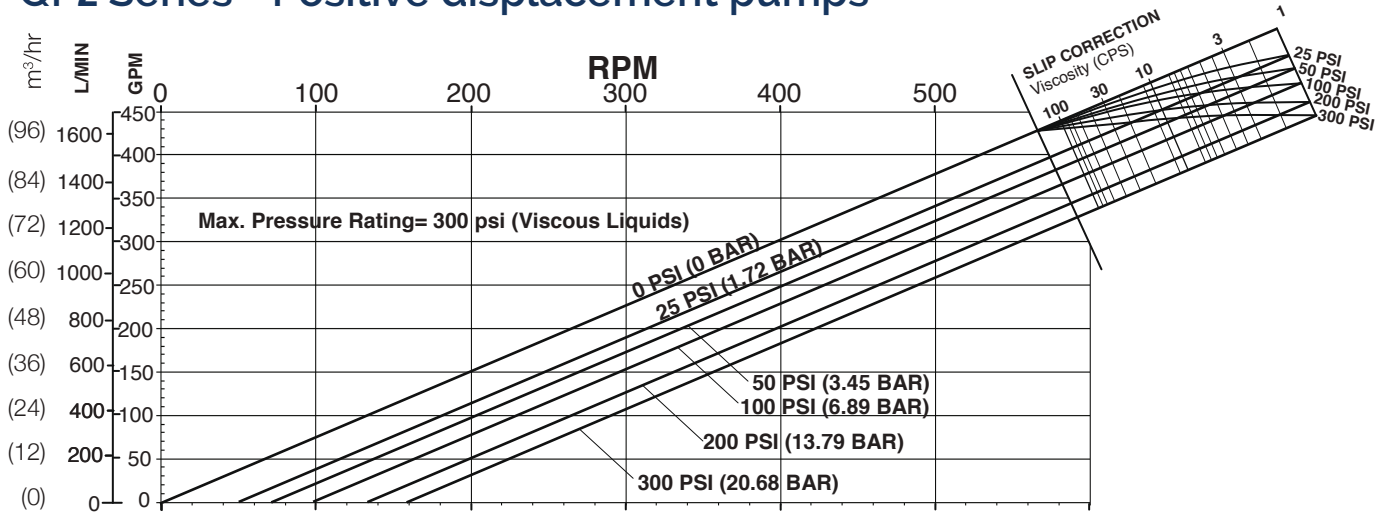

QP Series  
Model QP2-320

Standard Clearances  
Standard Port Size = 6.0"  
Displacement =  
0.720 Gal/Rev  
(2.725 L/Rev)

**BHP = WHP + VHP**

- Operating Specifications:
- 0-600 RPM Range
  - 300 PSI (20.68 bar) Max. Pressure
  - Temperature Range -40 °F (-40°C) to 300 °F (149°C)

Subject to change without notice